**Siemens S7-200PLC Ethernet Adapter
ES-ETH-PPI**

USER MANUAL

All rights reserved

INDEX

Preface	3
Copyright Statement.....	3
Version Info	3
Related Documents	3
Product Content.....	4
(1)Characteristics & Technical Parameters.....	4
(2) External Structure &Pin Definition.....	6
(3)Inner Diagram	8
(4)Parameters Setting	8
(5)The usage in the LAN	14
1. STEP7 Micro/WIN software setting	14
2. The communication between the PC and a S7-200PLC.....	18
3. The communication between the PC and multiple S7-200PLCs.....	19
4. The intercommunication among the multiple S7-200PLCs.....	25
(6) Remote communication in the internet	26
1. STEP7 Micro/WIN software setting	27
2. Remote communication between PC and S7-200PLC	30
3. Remote communication between two PCS S7-200PLCs	35
(7) Remote wireless communication in the 3G wireless internet.....	39
1. STEP7 Micro/WIN software setting.....	39
2. Remote wireless communication between PC and S7-200PLC.....	40
3. Remote wireless communication between two PCS S7-200PLCs	40
(8)Ordering Info.....	41
(9) Appendix: basic knowledge of Ethernet.....	41
1. TCP.....	41
2. UDP	42

Preface

Thanks a lot for your choosing our products.

Before you use, please be sure to read this manual carefully, you will know its powerful and perfect function and simple use.

This adapter is used for the communication between Siemens S7-200PLC and Ethernet, Internet or 3G wireless network by the programming interface (RS485 interface) of S7-200 PLC. Please use according to the manual, we won't assume any liability of property damage or personal injury due to your improper use.

We have the right to revise this manual at any time according to the needs of technology development and it won't be noticed before the revising.

Copyright Statement

Any people and institutions copy all or part will assume the corresponding legal responsibility without prior written consent.

Version Info

Document Name: 《ES-ETH-PPI user manual》

Version: V2.0

Revising Date: September, 20, 2010

Related Documents

In order to use this adapter better, please also read the following two documents:

1. 《Device Manager Parameter Setting Software Manual》
2. 《VCOMM Virtual Serial Port Software Manual》

Product Content

1. ES-ETH-PPI 1PC
2. RJ45 Cable 1 PC,2 M
- 3.CD 1PC

(1) Characteristics & Technical Parameters

ES-ETH-PPI is the industrial product which use the Ethernet and Internet or 3G wireless network to achieve Siemens S7-200PLC networking communication. It integrates many complex network protocols, support TCP Server,TCP Client,UDP Unicast,UDP Multicast etc many modes.It has 10M/100M adaptive Ethernet interface and 10-bit and 11-bit RS485 interface which meets Siemens technical specifications.You only need to go on simple setting and then let the S7-200PLC go on network communication.

The RJ45 port,RS485 interface and power supply port are all isolated in order to suit harsh environment in the industrial situations. Especially the isolated power supply port and each signal pin has anti-static protection and surge protection which can solve the communication port easily damaged problem for Siemens S7-200PLC.

Notice: When ES-ETH-PPI is used to communicate between PC and S7-200 PLC,you need to set the local connection as "Modem connection" in the STEP7 Micro/WIN software.When it's used to communicate between PLC and PLC,you only can use the free port RS485 communication mode,can't use Siemens PPI,multi-master PPI or advanced PPI protocol,also MPI and profibus protocol.

- ◆ High-speed, reliable industry standard, anti-interference design suit for the harsh electromagnetic environment
- ◆ 32 bit RISC (NP7 series) ARM7TDMI 55DMIPS
- ◆ 128KB SRAM, 128KB Code + 32KB Boot
- ◆ 10M/100M adaptive Ethernet interface
- ◆ Support Siemens technical specifications 10-bit and 11-bit RS485 communication mode
- ◆ Support RS485 data bits 5, 6, 7, 8 settable
- ◆ Support RS485 stop bit 1, 1.5, 2 settable
- ◆ Support RS485 Parity NONE,ODD,EVEN,MARK,SPACE settable

- ◆ Support RS485 baud rate 110~115200bps standard baud rate settable, not support 187.5Kbps baud rate
- ◆ Support PPI communication of RF modem and free port RS485 communication, not support advanced PPI and multi-master PPI protocol
- ◆ Protocols: TCP,UDP,ARP,IP,ICMP,DHCP,BOOTP,DNS
- ◆ Support Dynamic DNS
- ◆ Working mode can be chose TCP Server、TCP Client、UDP multicast and UDP unicast.
- ◆ Built-in Flash memory, can save the setted parameters
- ◆ Support Windows 95/98/ME/NT/2000/XP/2003/XP/Vista/Win7
- ◆ RJ45 port 1500VDC electromagnetic isolated, RS485 interface 1000VDC electromagnetic isolated, power supply 1000VDC electromagnetic isolated
- ◆ Interface protection: power supply port has the reverse polarity protection and over current protection,RS485 interface has the 500W anti-lightning surge protection and overcurrent protection; all pins and terminals have anti-static protection
- ◆ 24V±10% DC power supply from PLC RS485 socket,1W power
- ◆ Dimension: 65mm×51mm×26mm, 35mm standard rail installation
- ◆ Temperature: -40°C to +80°C (-40°F to 176°F), 5% to 95% RH

(2)External structure &pin definition

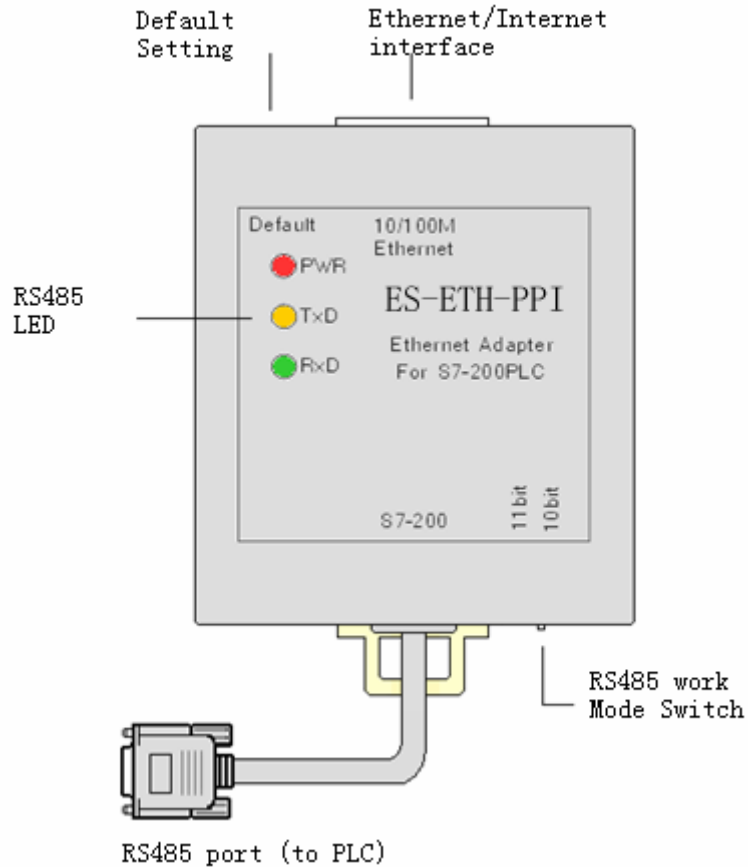

Ethernet interface: Standard RJ45 socket, automatically adapt 10M/1000M Ethernet .Use the standard network cable, not crossover cable whether you connect the switch or directly connect the PC.

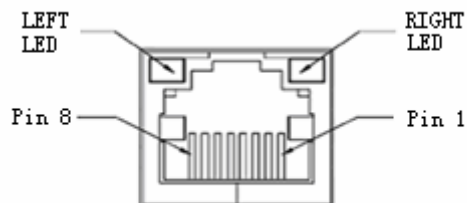

The network status LED indicator on the RJ45 socket

LINK LED (LEFT, GREEN)		ACT LED (RIGHT, YELLOW)	
State	description	State	description
Light on	Network cable is connected correctly, work properly.	Flash	Sending and receiving data through the RJ45 port
Flash	Network cable is not plugged in, no available network	Extinguish	No data transceiving

Ethernet interface RJ45 socket signal array

Pin	Signal name	Function	Type
1	Tx+	Positive phase Ethernet data sending differential signal line	output
2	Tx-	negative phase Ethernet data sending differential signal line	output
3	Rx+	Positive phase Ethernet data receiving differential signal line	input
4	Not used		-
5	Not used		-
6	Rx-	Negative phase Ethernet data receiving differential signal line	input
7	Not used		-
8	Not used		-

Default Button: Restore the default setted parameters. Insert the penpoint into the hole to press the button for about 1 second, the internal Flash memory parameters will restore to factory default parameters: IP = 192.168.0.250, Username = admin, Password = admin. When you forget the IP address, user name or password, you can restore to the factory default parameters, and then reset the parameters.

RS485 Interface: RS485 interface is the DB9M-pin plug which meets the Siemens S7-200 Series PLC PPI interface technical specifications, the signal array match S7-200 series PLC PPI interface, and has a 0.5 meter cable, you just simply plug the DB9M directly into the S7-200PLC PPI interface outlet.

The signal array of RS485 socket(DB9M pin)

Pin No.	Signal name	Description	Input/output
1	NC	No use	-
2	M24V	24VDC power negative	input
3	LTG_B	RS485 signal positive	input/output
4	NC	No use	-
5	M5V	RS485 signal ground	input
6	NC	No use	-
7	P24V	24VDC power positive	input
8	LTG_A	RS485 signal negative	input/output
9	RTS_PG	RS485 communication mode selection	input
Shell	Shielding	Shield ground (chassis ground)	

RS485 communication mode selection switch: you need to set the local connection as “modem connection” in the STEP7 Micro/WIN software when you use the ES-ETH-PPI . At this time, you need to choose 11-bit or 10-bit data communication mode.

11-bit mode	8E1 communication mode with even parity, is usually used for LAN(intranet)communication.
10-bit mode	8N1 communication mode without parity , is usually used for Internet (Extranet) or 3G wireless network communication.

RS485 communication indicator: there are three LED indicators on the panel, and its working state as the following table:

Indicator	Light on	Flash	Extinguish
(Red)	Power supply normal	Fault	Fault or no power
TxD (Yellow)	Fault or signal polarity reversal	Serial port is receiving the data	Fault or no communication
RxD (Green)	Fault or signal polarity reversal	Serial port is sending the data	Fault or no communication

(3)Inner Diagram

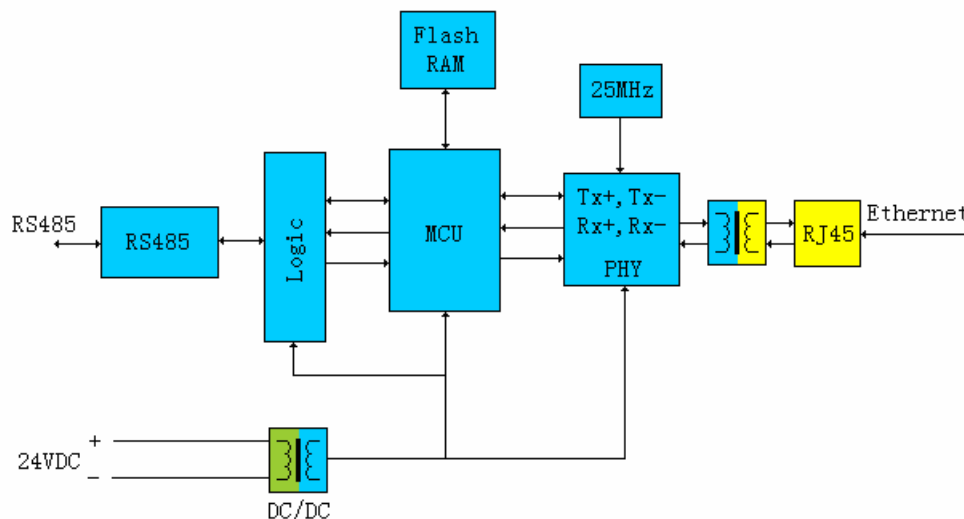

(4)ES-ETH-PPI parameters setting

ES-ETH-PPI needs to be configured the parameters to work correctly, the configuration parameters including the network parameters, communication protocols, connection, serial port parameters; it can be very flexible to satisfy your application. Configuration parameters are stored in the Flash memory, and they can be permanently stored without loss.

Use the standard RJ45 cable to connect the ES-ETH-PPI and router or switch, at the same time make sure that the router or switch is connected to a computer in order to run the parameters setting software .You also can use a standard RJ45 cable to directly connect ES-ETH-PPI and the computer, no need crossover cable, this product has auto-polarity discrimination function for the RJ45 cable.

Plug the RS485 (DB9M) of ES-ETH-PPI into the S7-200PLC RS485 socket and power on the PLC. The same local area network (router) can connect multiple ES-ETH-PPI, but the same IP address is not allowed, there will be conflicts if the same IP, and it only shows one of IP and abnormality.

You can press the Default button on the ES-ETH-PPI any time that could make it restore to the factory default.

IP=192.168.0.250, Username=admin, Password=admin

You need to check your computer's IP address and gateway address, and confirm your computer is in the normal Internet access, in the next setting, you need to set the gateway of ES-ETH-PPI as same as the gateway of computer and router, that is to say, the ES-ETH-PPI and computer are in the same subnet, all equipments in this subnet and routers have the same gateway.

Right-click Network Neighborhood> View Network Connection> Properties, then pop up "Local Area Connection Properties" window:

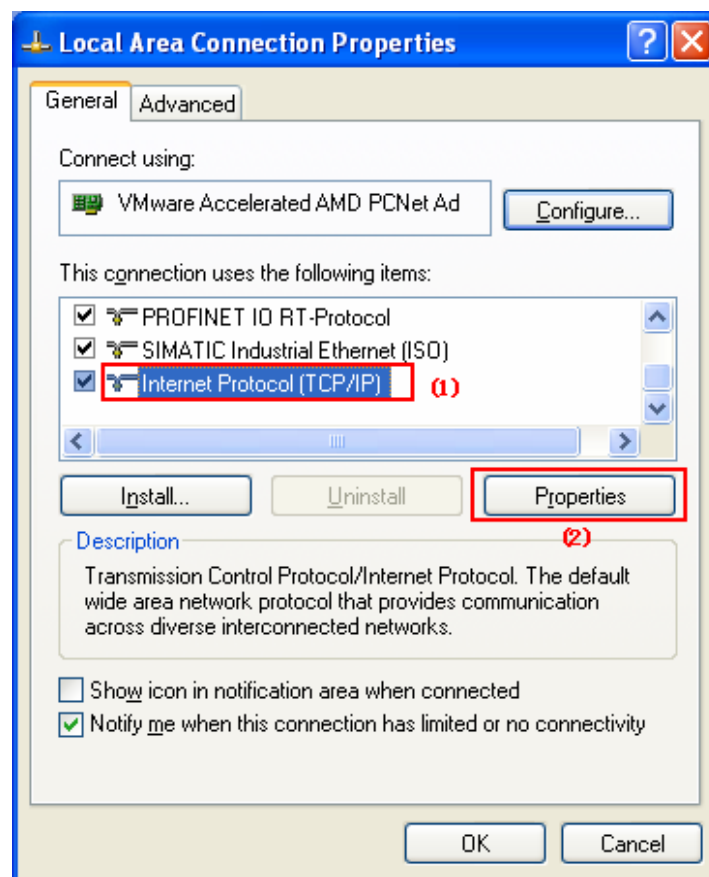

Select the General page; click the Properties then pop-up the following window, record the IP address and the gateway of the computer for later use:

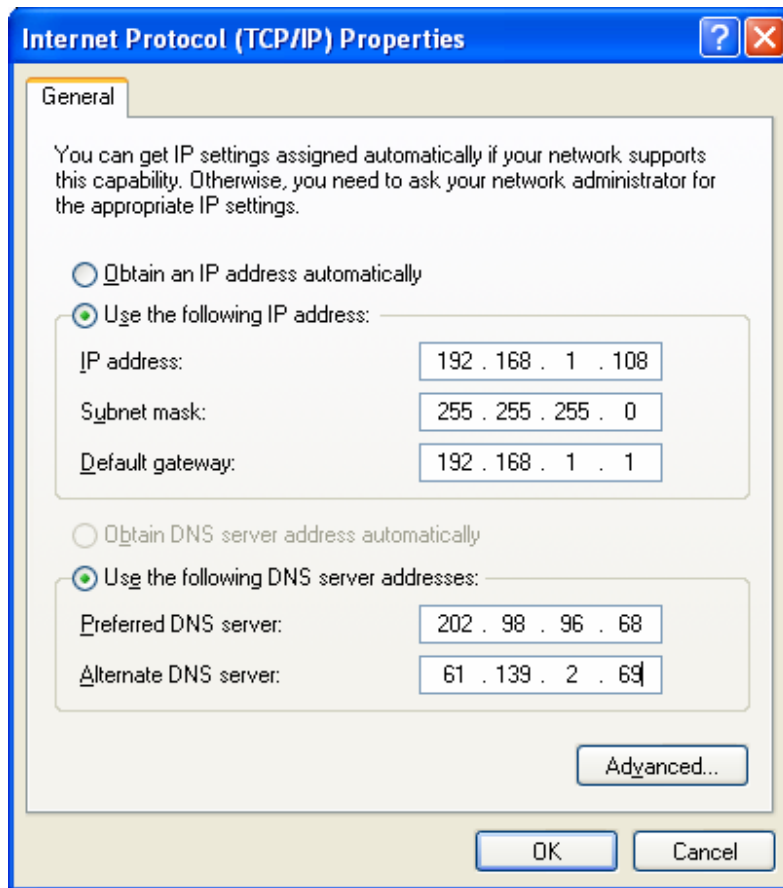

Copy the OEM Device Manager_SPCNML.rar file on the CD to your hard disk and extract it to the current folder, do not modify the folder name "OEM Device Manager_SPCNML" which store the setting software. Double click the following icon in the OEM Device Manager_SPCNML folder to run setting software:



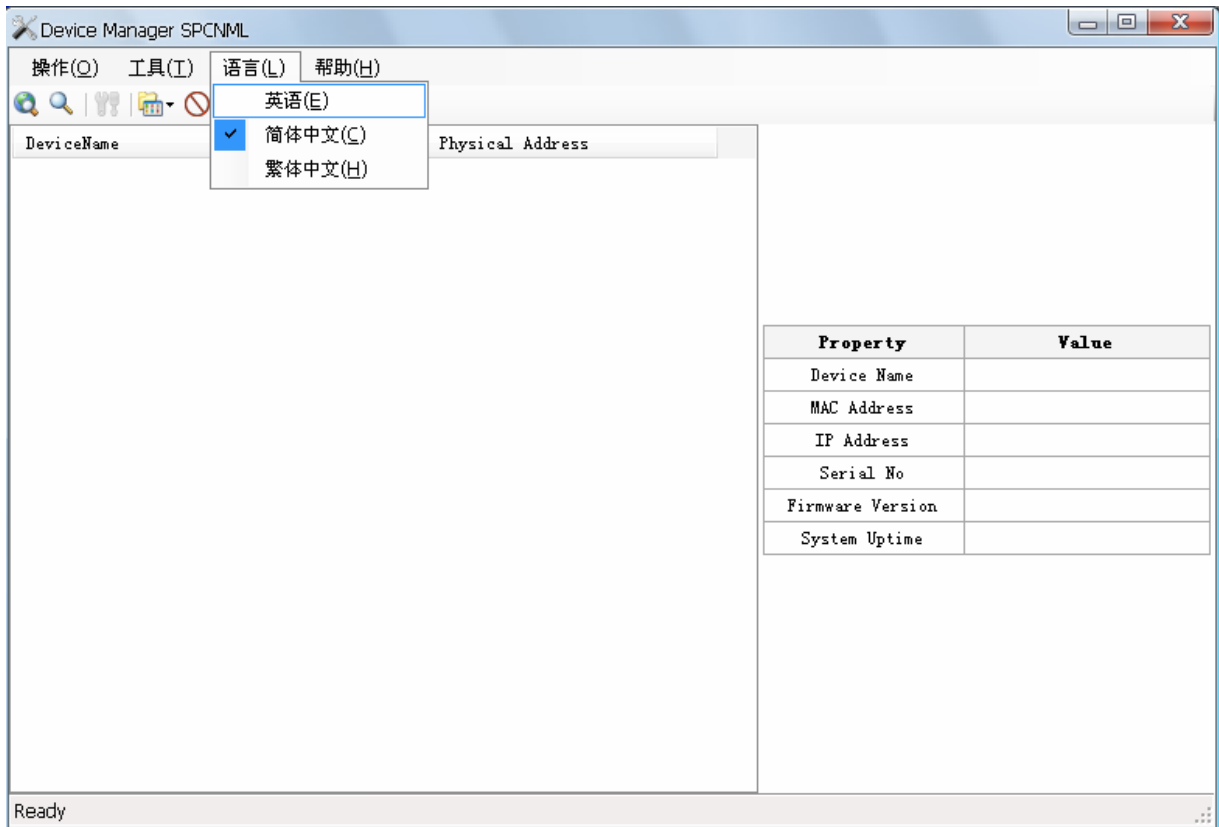

Change language to English: Ctrl+L and then press “E”, or select the menu as the picture up

Click the Search button in the upper left corner, and then search out all ES-ETH-PPI connected to the router after a few seconds, as shown below:

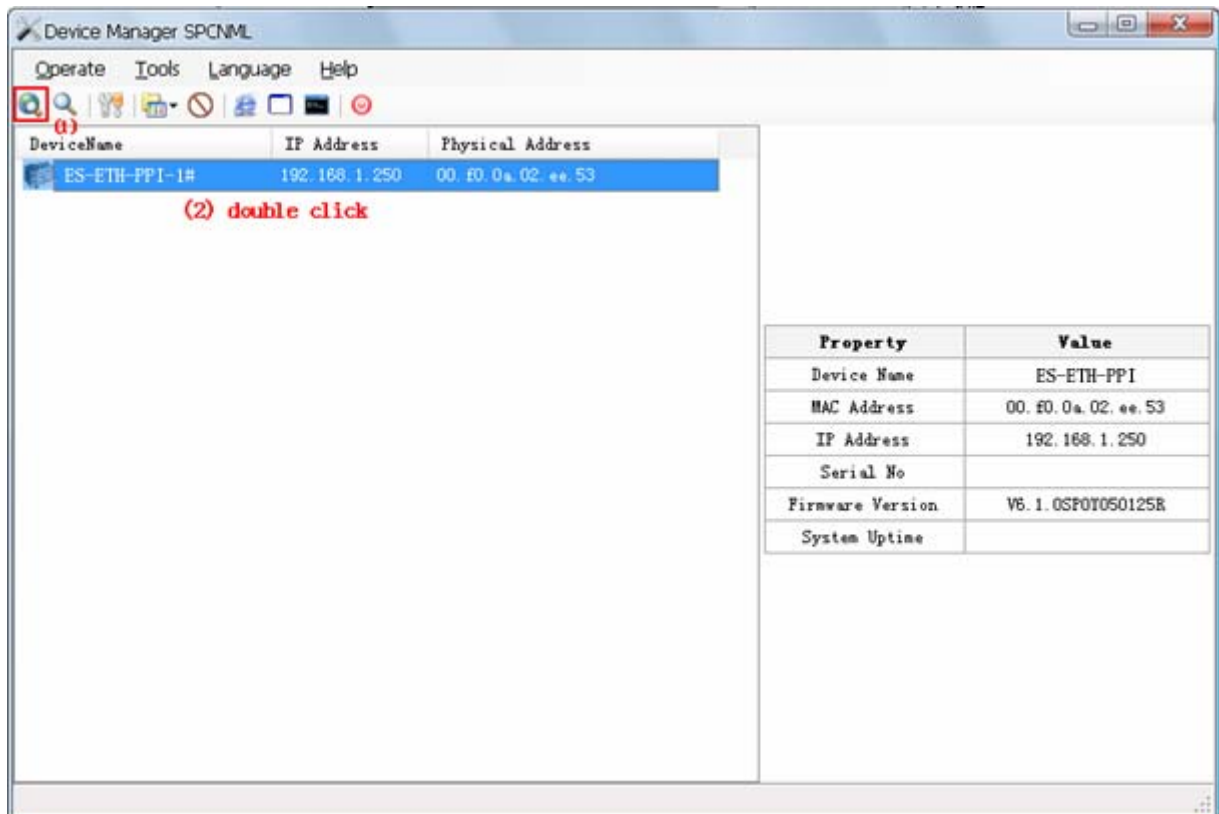

Double-click the ES-ETH-PPI, pop-up dialog box, enter your user name and password to enter the setting interface. The factory default setting: Username = admin, Password = admin

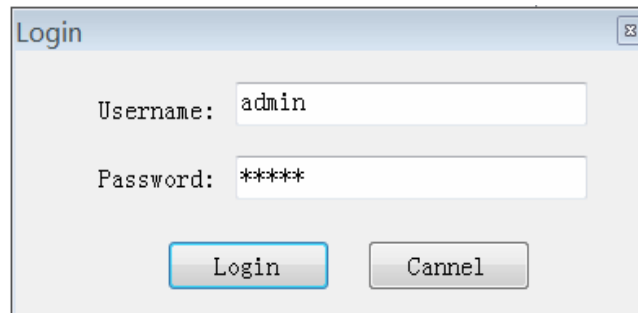

Click "Login" to enter the configuration interface.

You must firstly click "OK" to effect the modified parameters(parameters not saved at this time) after you modify the parameters in every interface ,then click the "Apply Settings / Restart" to save parameters and restart the ES-ETH-PPI to work with the new parameters and then exit the setting software. As shown below:

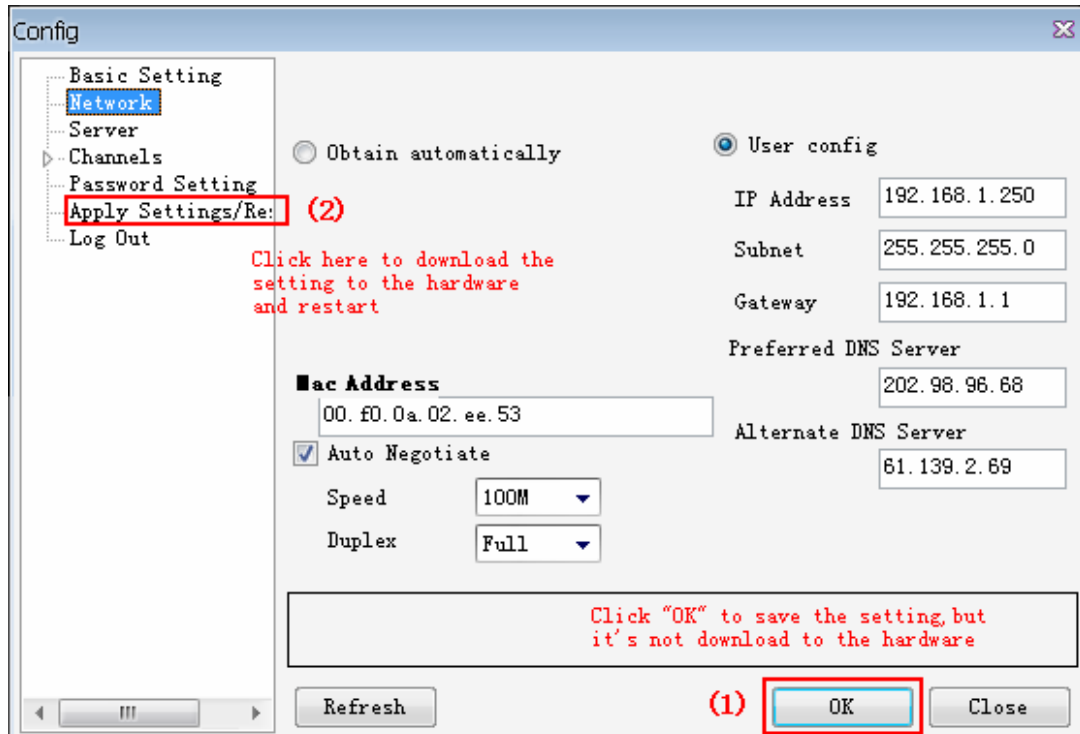

About the parameters configuration details, please read the "Device Manager Parameters setting software manual".

After you configure the ES-ETH-PPI parameters, you need to run VCOMM virtual serial port software on the PC, simulate the ethernet interface of ES-ETH-PPI as serial port (COM port) on

the PC, then choose this serial port in the local connection of STEP7 Micro/WIN software ,as the same as you use the traditional PC/PPI programming cable.

Notice:The COM port of local connection in the “set PG/PC interface” menu of Siemens programming software STEP7 Micro / WIN can most support COM8, even though it can display above COM8, in fact it can't use.

About the detailed instructions of the VCOMM virtual serial port software, please read " VCOMM virtual Serial Port software Manual.

Siemens S7-200PLC 11-bit RS485 interface communication parameters: data bits = 8 bits, parity = EVEN (even parity), stop bit = 1, referred to as: 8E1. This is the PLC default mode.

Siemens S7-200PLC 10-bit RS485 interface communication parameters: data bits = 8 bits, parity = NONE (no parity), stop bit = 1, referred to as: 8N1.This mode is used in the Internet communication.

S7-200PLC baud rate = 9.6Kbps or 19.2Kbps , ES-ETH-PPI does not support 187.5Kbps baud rate. Firstly please use such as PC / PPI programming cable to check the PLC baud rate,and the ES-ETH-PPI serial port parameters must be set as the same parameters with the PLC, so we set S7-200PLC baud rate as 9.6Kbps in the following examples.

Firstly set ES-ETH-PPI serial port parameters in parameters setting software , where the serial port protocol box "RS232" option is supporting RS232/RS485/RS422 communication and must ensure that this serial port parameters and the S7-200PLC RS485 interface parameters are the same, Otherwise, It can't normally communicate.

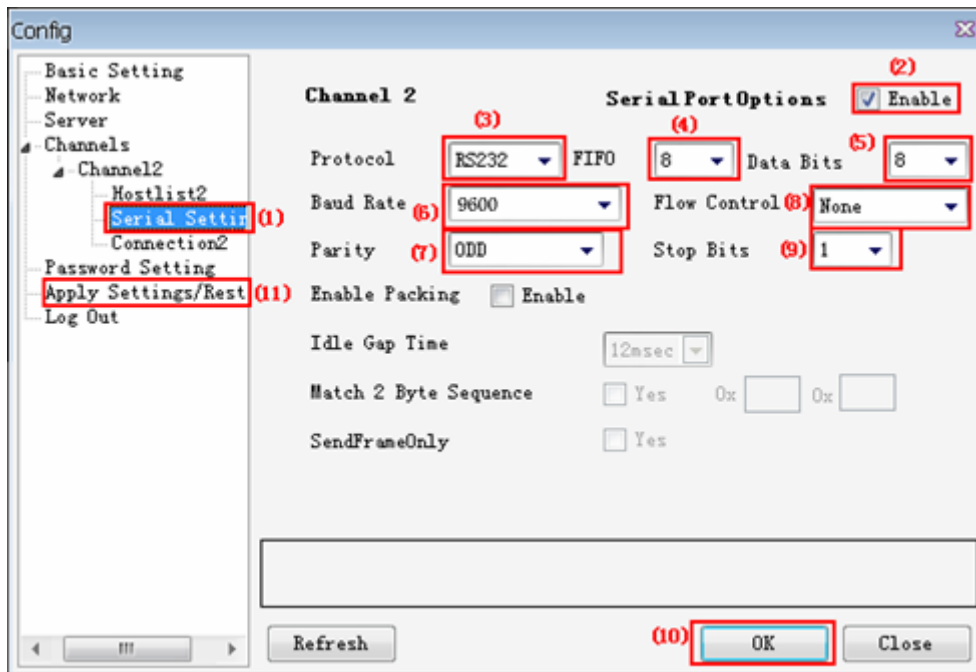

The application of ES-ETH-PPI is very flexible and diverse, not limited to examples described below. You can use the ES-ETH-PPI to connect the S7-200PLC to the Ethernet in order to achieve the data communication from PLC to PC, PLC to PLC, multiple PLCs to PC and among multiple PLCs etc. It can also be achieved the worldwide data communication through the Internet, or wireless data communication through wireless LAN, 3G network card, 3G router.

(5) The usage in the LAN

LAN communication generally refers to the same gateway, that is to say, the communication is among multiple Ethernet devices which are connected to a same router.

The ES-ETH-PPI communication in the LAN needs to ensure that PC, ES-ETH-PPI and routers have the same gateway, The gateway: 192.168.1.1, the computer IP address: 192.168.1.108, ES-ETH-PPI IP address: 192.168.1.250 in the following examples.

1. STEP7 Micro/WIN software setting

Select RS485 communication mode switch on the ES-ETH-PPI to "11bit", use the even parity 11 bit communication mode, then use the setting software to set ES-ETH-PPI serial port parameters as 9600bps, 8E1 (8 data bits, even parity, 1 stop bit).

When the VCOMM virtual serial port software running on the PC simulate ES-ETH-PPI as the COM port on the PC, the next using is just like PC / PPI programming cable, but you should set the local connection in the "set PG/PC interface" menu of STEP7 Micro / WIN software as "modem

connection" mode.

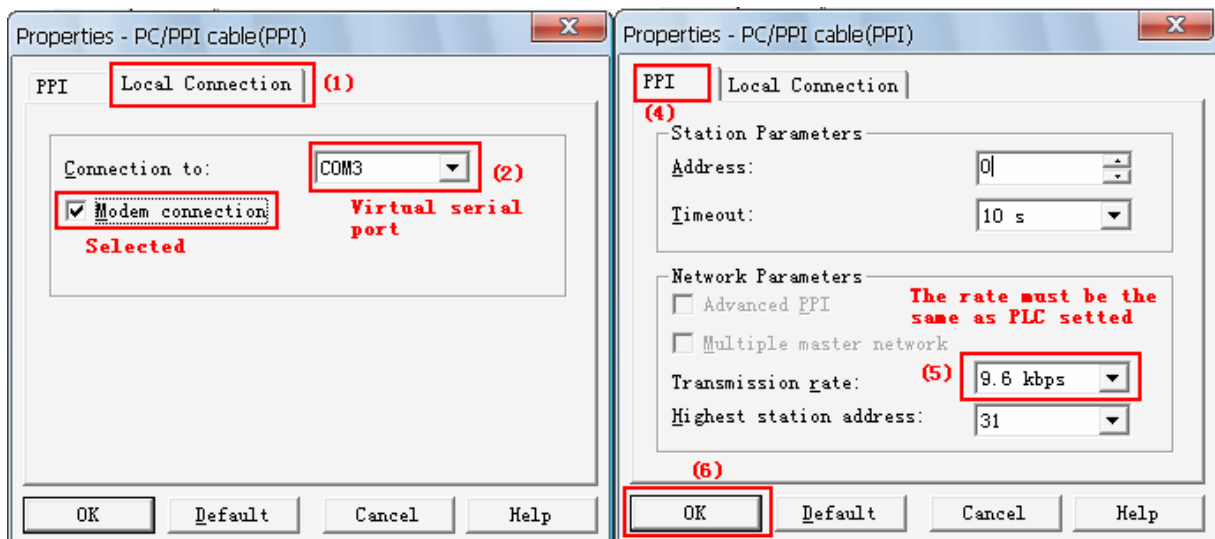
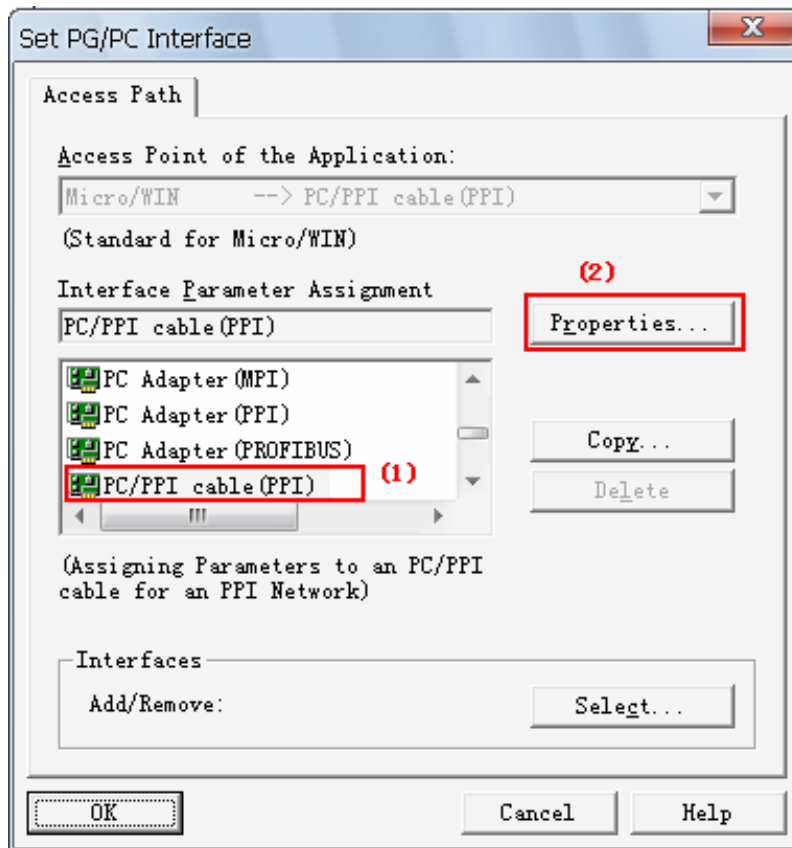

Click the "Communication" button to enter the communication settings, double-click "connection" to set the modem parameters.

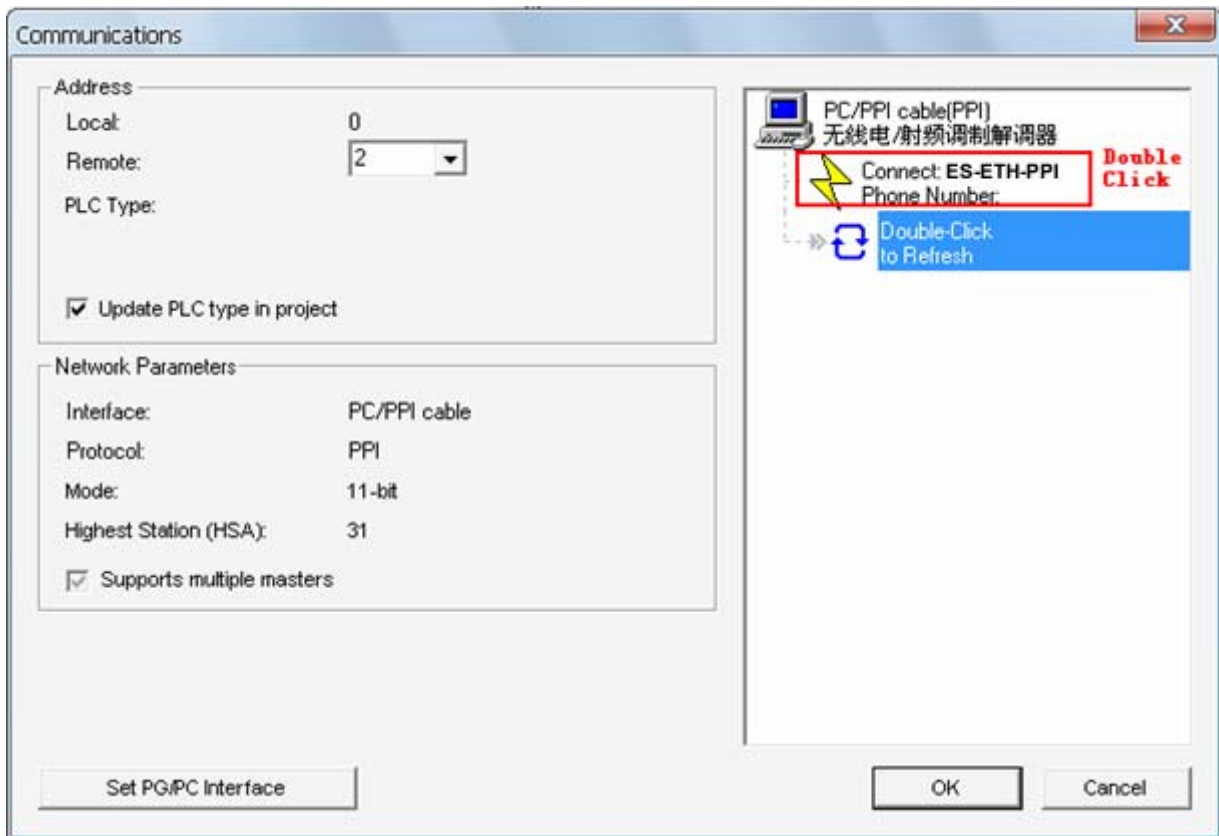

Select the "modem connection" and configure serial port parameters, choose even parity 11 bit mode.

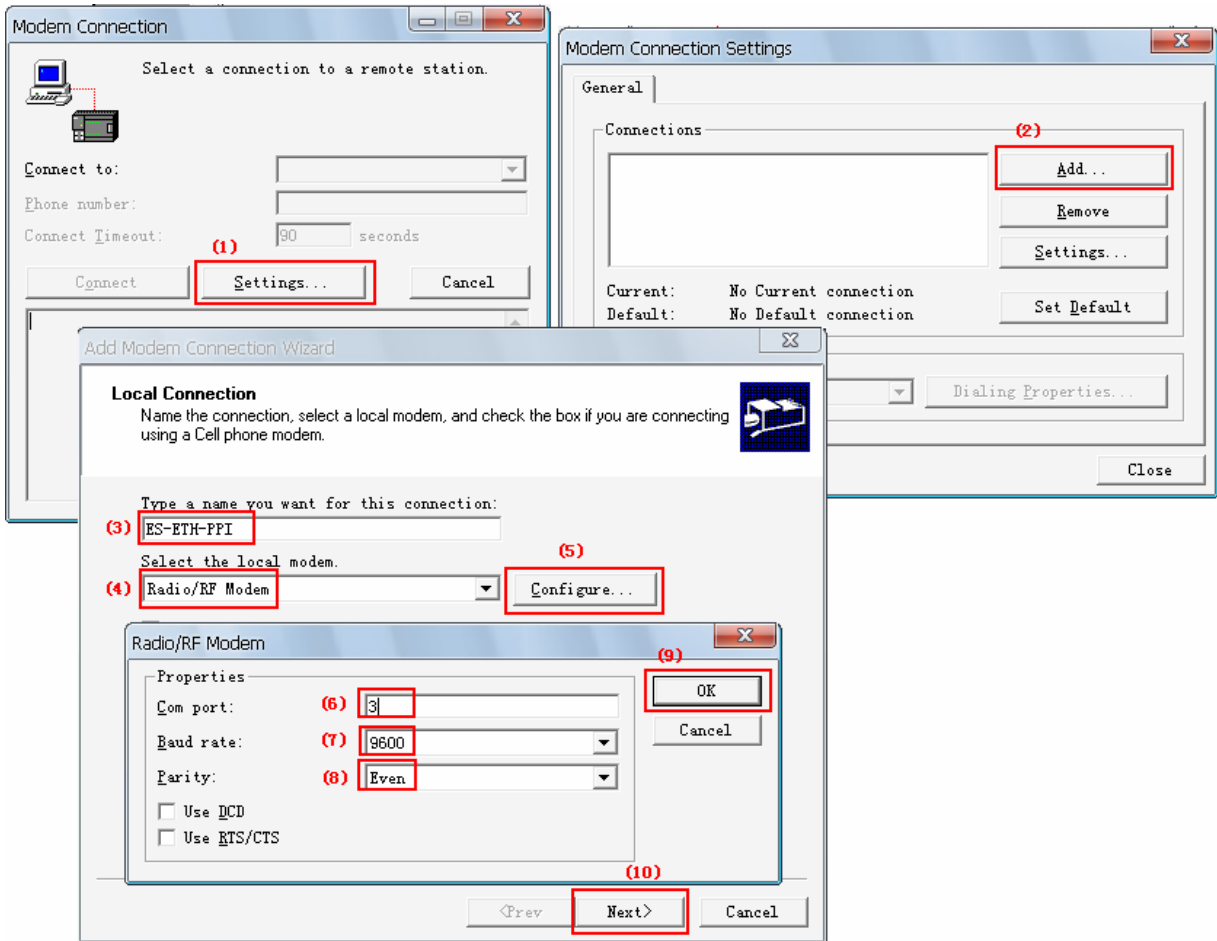

Click "Connect" button to establish the connection.

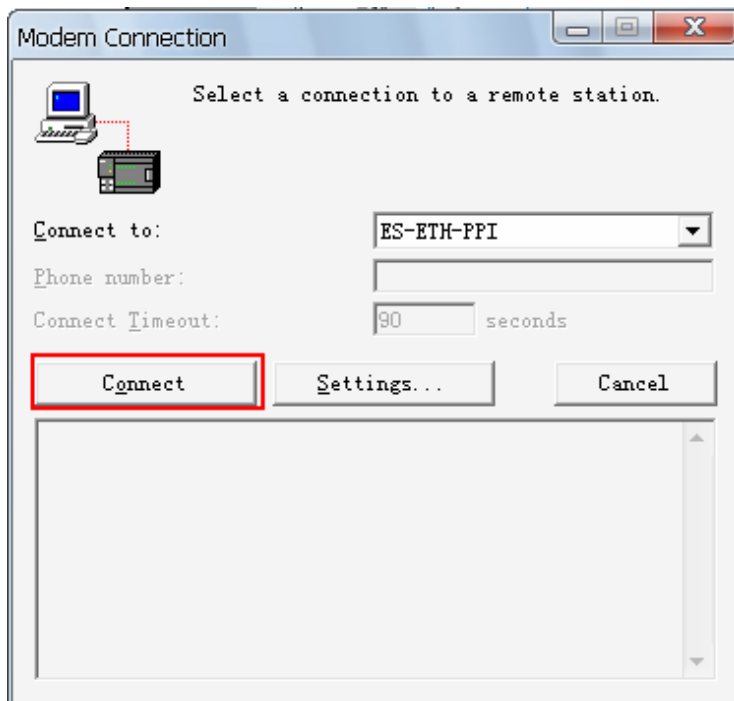

Double-click the "Refresh" to search the PLC, and then you can find the all PLCs connected to the network, then select the PLC which you want to operate, in the next step you can upload, download the data.

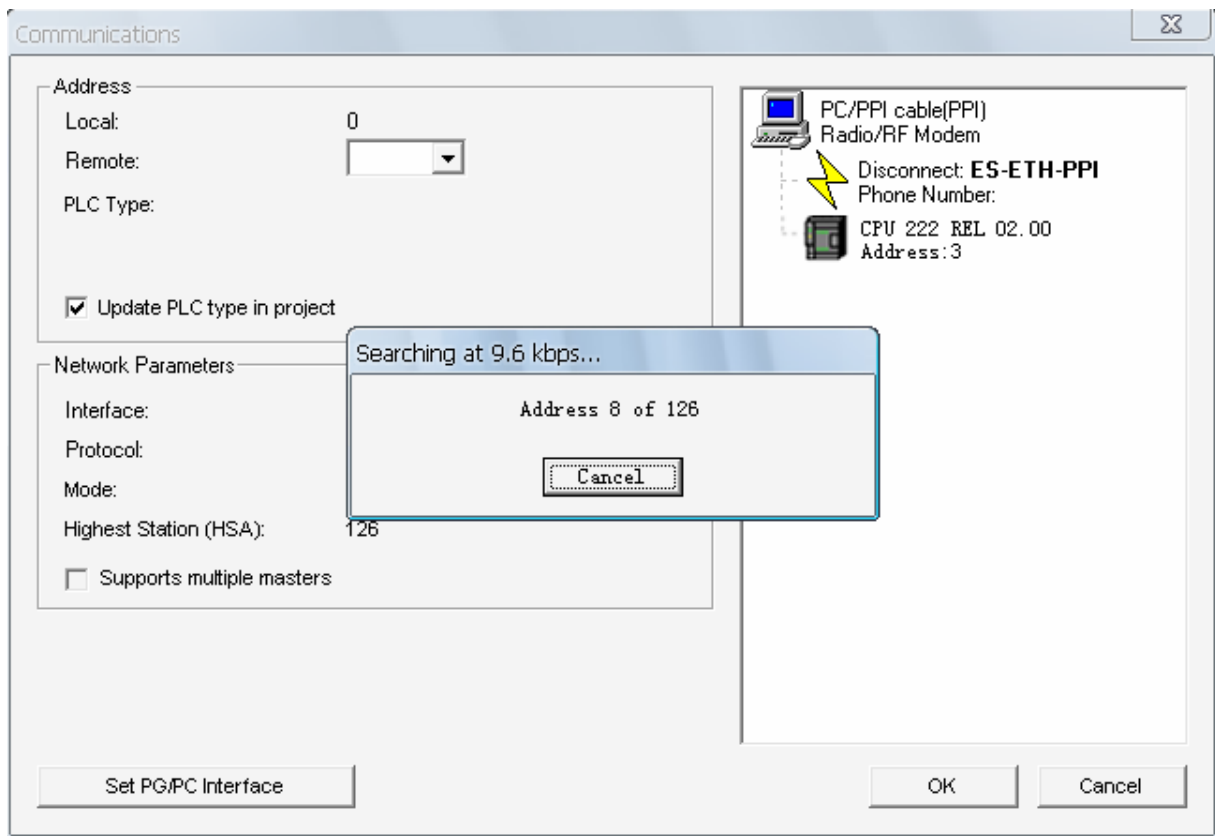

2. The communication between the PC and a S7-200PLC

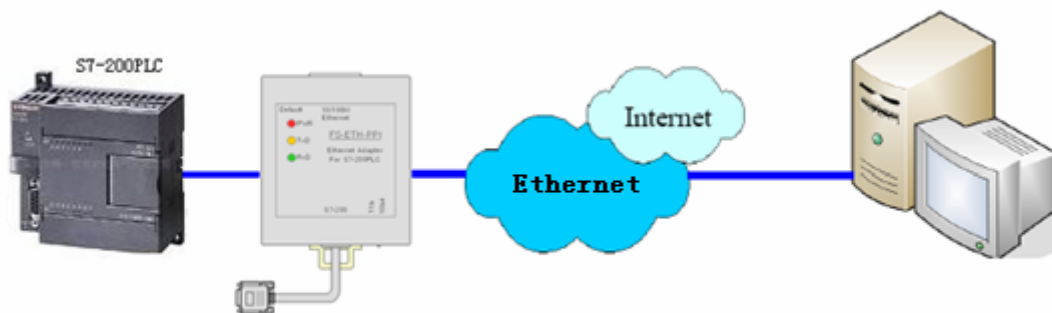

Set the ES-ETH-PPI network parameters, the gateway of ES-ETH-PPI, PC and router must be same, the DNS server needn't to be setted because you don't use the dynamic domain name on the Internet.

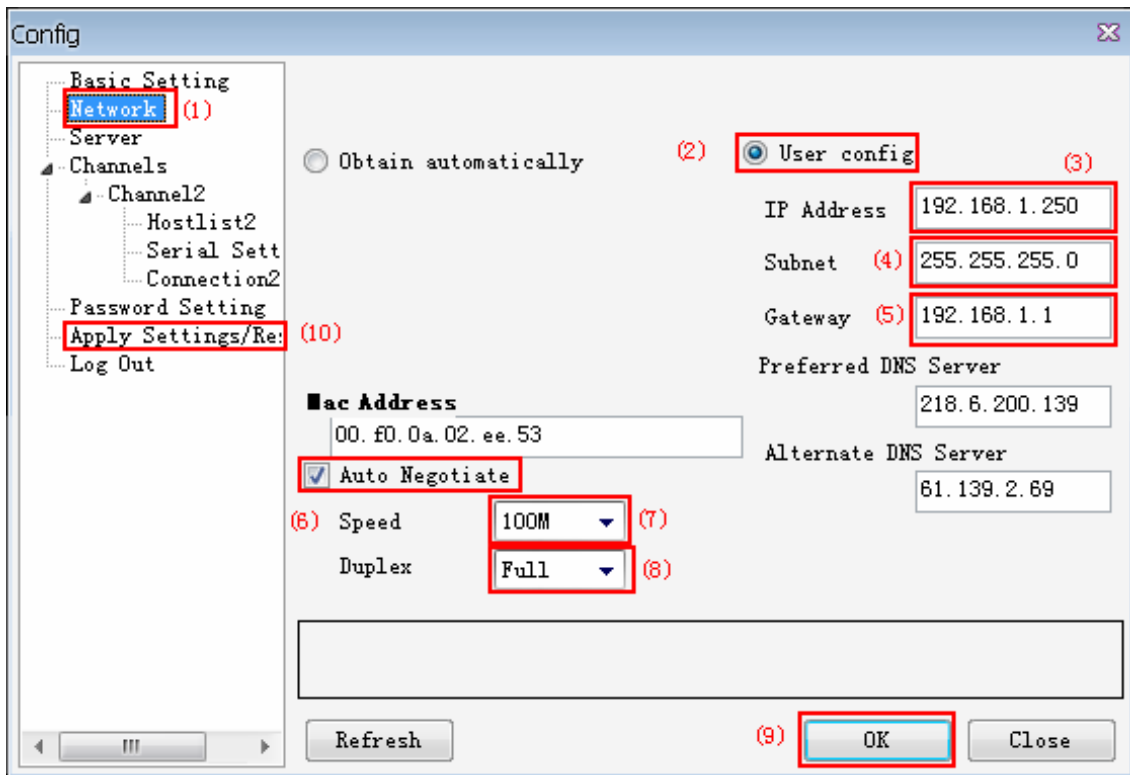

The setting of ES-ETH-PPI serial port parameters is omitted here, you can see the previous description.

Set ES-ETH-PPI working mode as TCP Server, port No. = 27011, waiting for clients to connect.

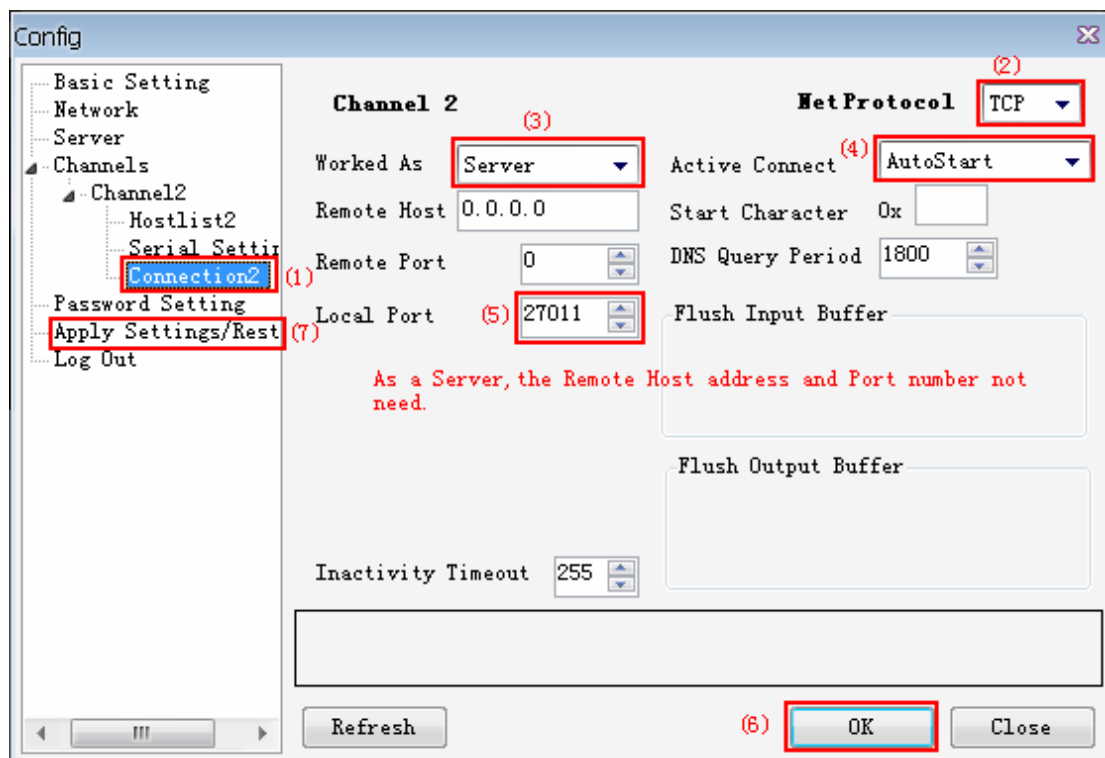

Run the VCOMM virtual serial port software on the PC, set the simulated virtual serial port on the PC. Select VCOMM as Client mode, initiatively to connect the server-side equipment. Choose the device detector to create the virtual serial port.

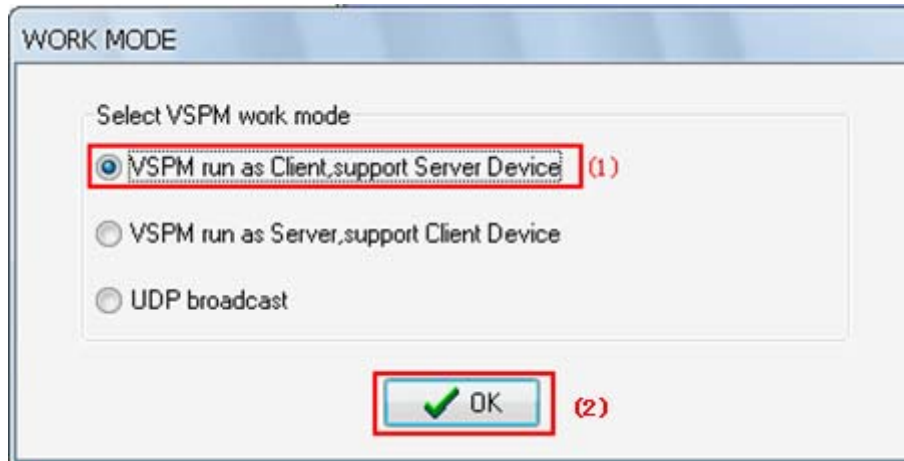

Add a virtual serial port, the remote server IP address = ES-ETH-PPI IP address, remote server monitoring port = ES-ETH-PPI port.

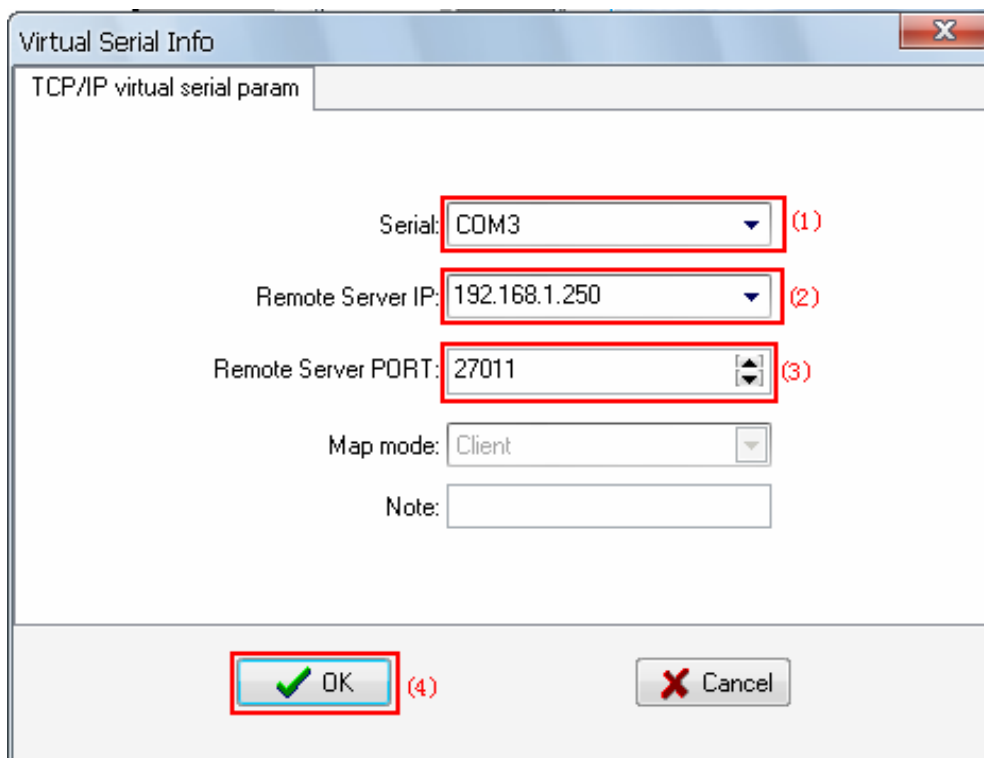

Click OK and exit the software and re-run VCOMM, the client side VCOMM will take the initiative to connect the server side with IP address 192.168.1.250, port number 27011, it will create a new serial port COM3 after establishing the connection, and it will appear in the Device Manager of the Windows system, then you choose this serial port in your application software, such as STEP7 Micro/WIN.

Virtual C...	Remote Server IP and PORT	State	COM->Network(Byte)	NetWork->COM(Byte)	Last State
COM3	192.168.1.250:27011	Close,0,N,0,1	0	0	TCP/IP Connected

Of course you can use ES-ETH-PPI to simulate each PLC as a COM port on the PC in order to achieve the data communication and monitoring operation between PC and multiple PLC s

3. The communication between the PC and multiple S7-200PLCs

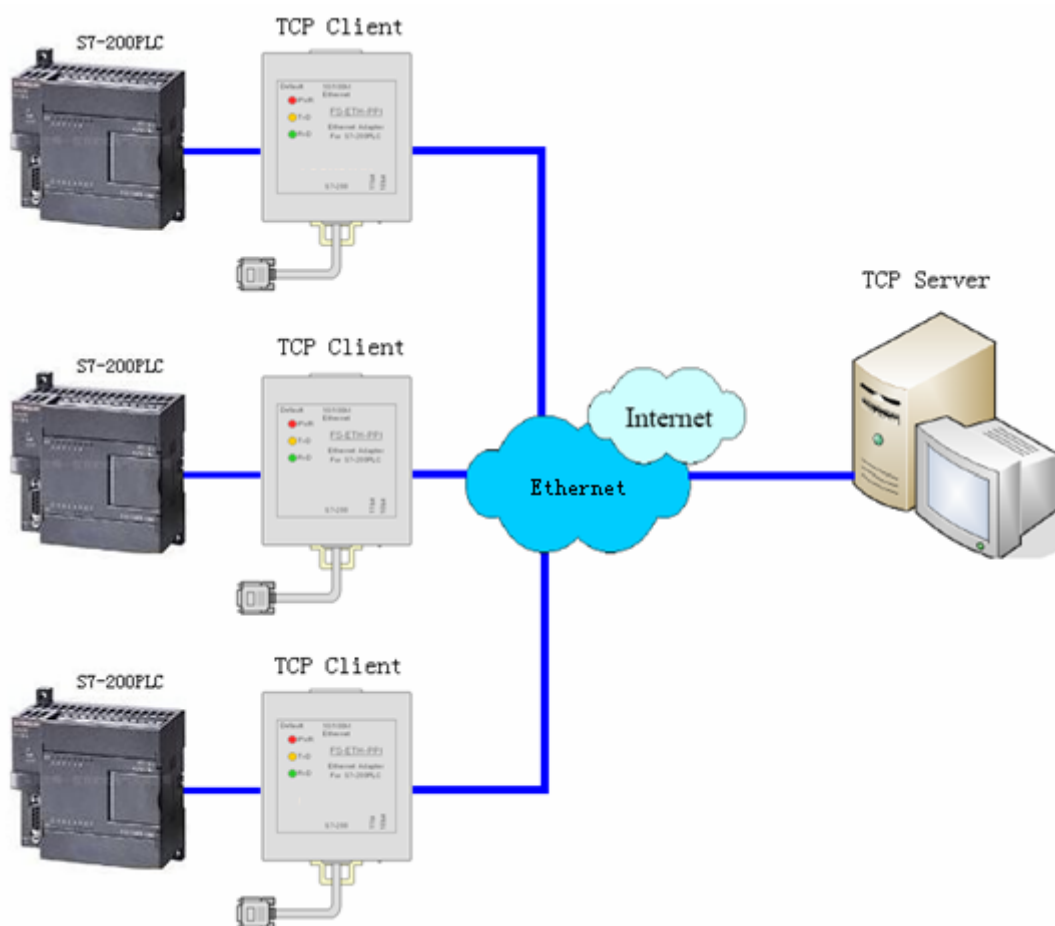

When multiple PLCs communicate with a PC via Ethernet, you need to set every ES-ETH-PPI connected with PLC as TCP Client, set the PC as the TCP Server, let every client ES-ETH-PPI takes initiative to connect the server PC. When VCOMM Virtual Serial Port Software work as TCP Server,it allows unlimited number of connected clients.

Set the ES-ETH-PPI network parameters, the gateway of ES-ETH-PPI,PC and router must be same, the DNS server needn't to be setted because you don't use the dynamic domain name on the Internet. The picture below is a ES-ETH-PPI setted parameters, when there are multiple

ES-ETH-PPI, please note that each ES-ETH-PPI IP address must be set to the different addresses.

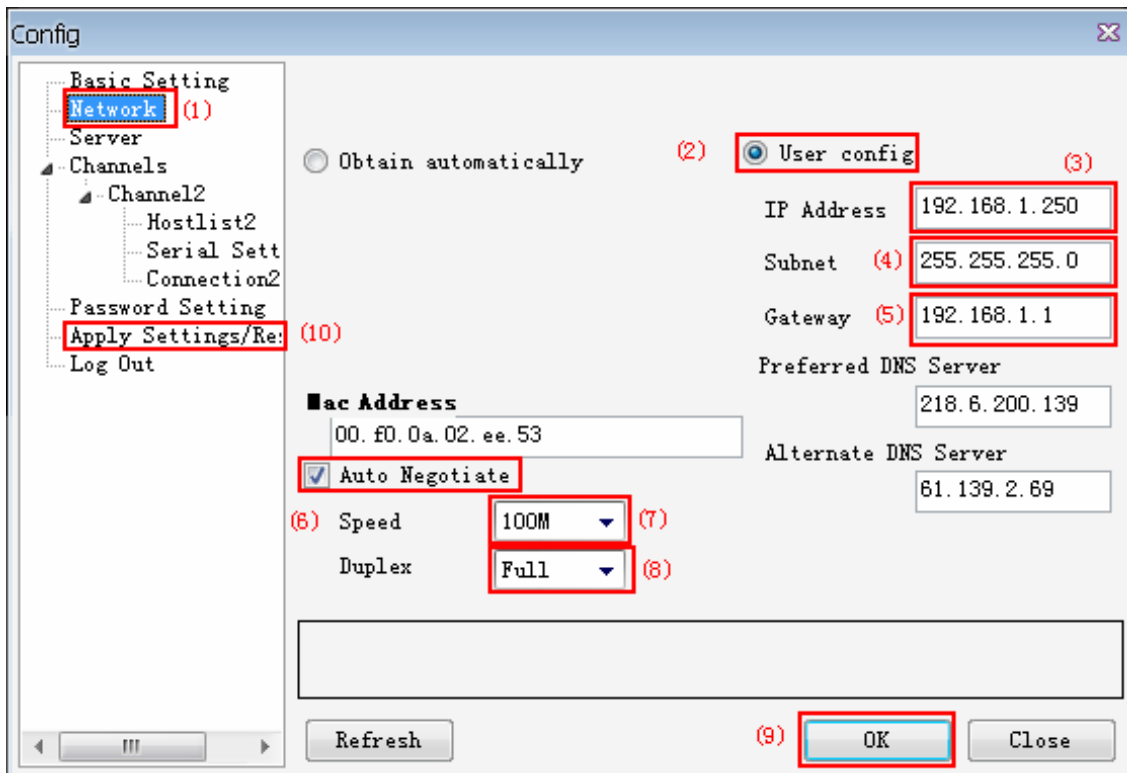

The setting of each ES-ETH-PPI serial port parameters are the same with PLC and they are omitted here, you can see the previous description.

Set each ES-ETH-PPI as the TCP Client, the remote host IP = PC IP address, host port = VCOMM software port number. That is to say, each ES-ETH-PPI have to connect to server-side VCOMM with IP = 192.168.1.108, port = 8000.

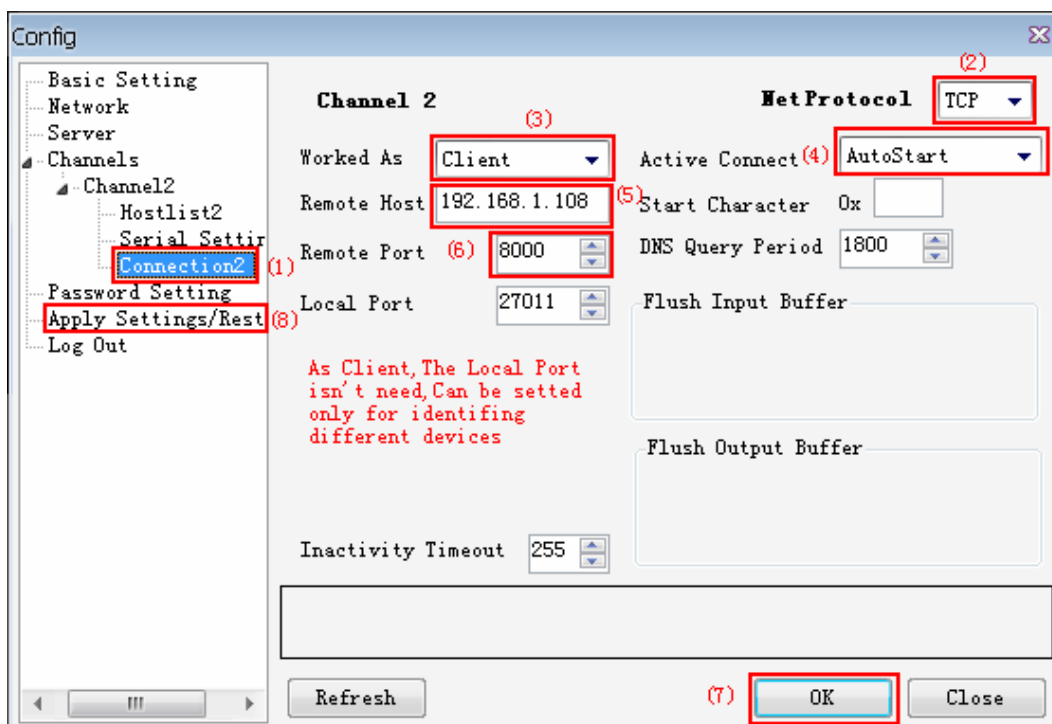

Run the VCOMM virtual serial port software on the PC, set the simulated virtual serial port on the PC. Select VCOMM as Server (server side) mode, accept client connection. Choose the device detector to create a virtual serial port.

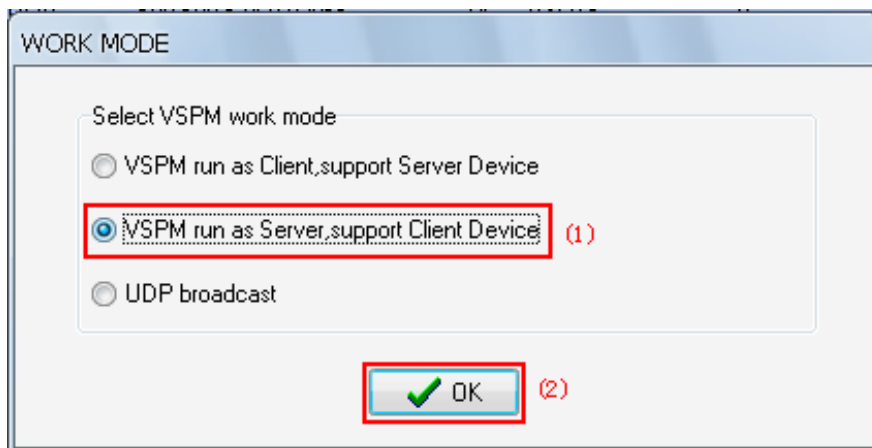

Add a new virtual serial port, the monitoring IP address = PC IP address, client mode device try to connect the port = VCOMM software port, this is 8000.

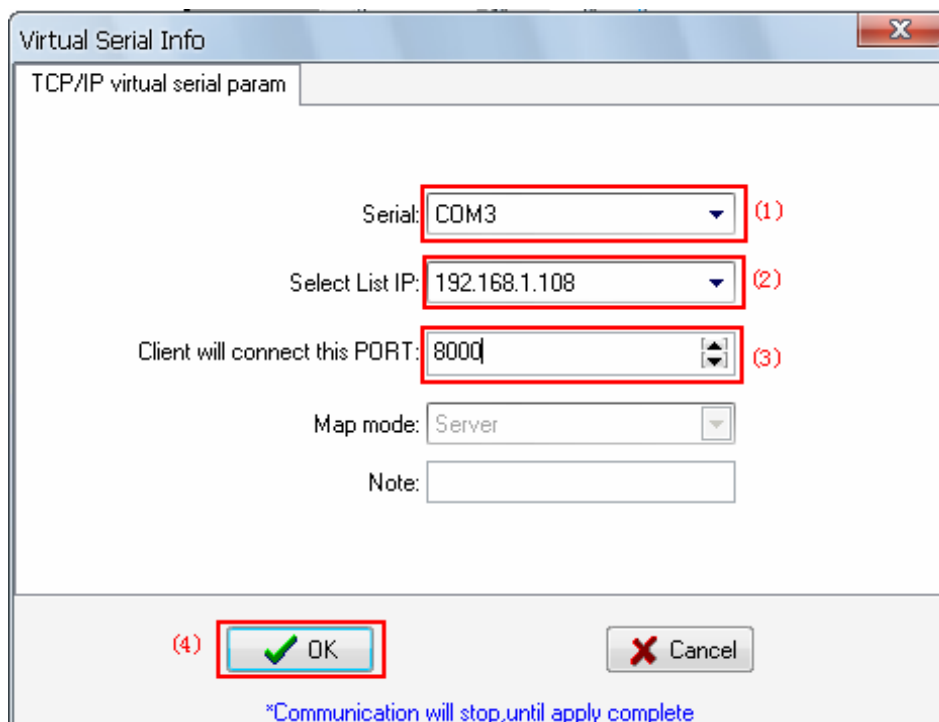

Click OK and exit the software and re-run VCOMM, server side VCOMM will accept as many as client side ES-ETH-PPI connections, and it's unlimited. A new serial port COM3 will appear on the PC after the connection is established. And this serial port will also appear in the Windows System Device Manager, then you can choose this serial port in your applications,like STEP7 Micro/WIN.

Virtual C...	Local list IP and PORT	State	COM->Network(Byte)	NetWork->COM(Byte)	Last Sta
COM3	192.168.1.108:8000	Close,0,N,0,1	0	0	

You can find the all PLCs via communication search of STEP7 Micro/WIN,as shown below.

Communications

Address

Local: 0

Remote: [Dropdown]

PLC Type:

Update PLC type in project

Network Parameters

Interface:

Protocol:

Mode:

Highest Station (HSA): 126

Supports multiple masters

PC/PPI cable(PPI)
Radio/RF Modem

Disconnect: **ES-ETH-PPI**
Phone Number:

CPU 222 REL 02.00
Address:3

CPU 226 REL 01.00
Address:5

Searching at 9.6 kbps...

Address 8 of 126

Cancel

Set PG/PC Interface

OK

Cancel

4.The intercommunication among the multiple S7-200PLCs

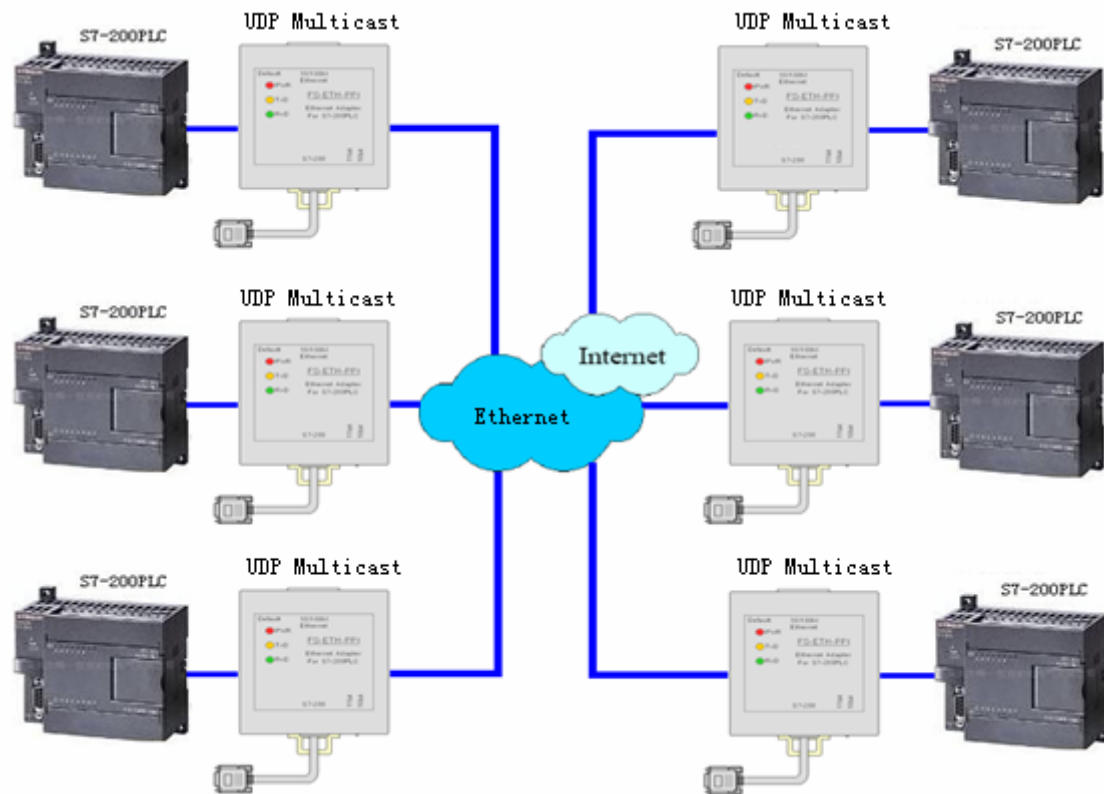

When multiple S7-200PLC need to exchange data each other, of course UDP multicast mode is the best working mode. Using UDP multicast can directly replace the original multi-point RS485 communication. But please notice that at this time the ES-ETH-PPI only supports S7-200PLC free port RS485 communication mode, do not support PPI,advanced PPI,Multi-master PPI communication protocol and MPI and profibus protocol.

About the setting of Multicast address, here is a brief introduction. In fact Multicast address is the Class D IP address, that's to say, the first byte of the upper 4 bits of the IP address is the 1110, so the multicast range: 11100000.00000000.00000000.00000000 ~ 11101111.11111111.11111111.11111111, 224.0.0.0 ~ 239.255.255.255. Some addresses have been occupied by the system, so you had better use the address above 224.1.1.1.

Here We use the multicast section address 224.224.224.224, all modules added in the multicast group (224.224.224.224:27011) can send and receive data each other.

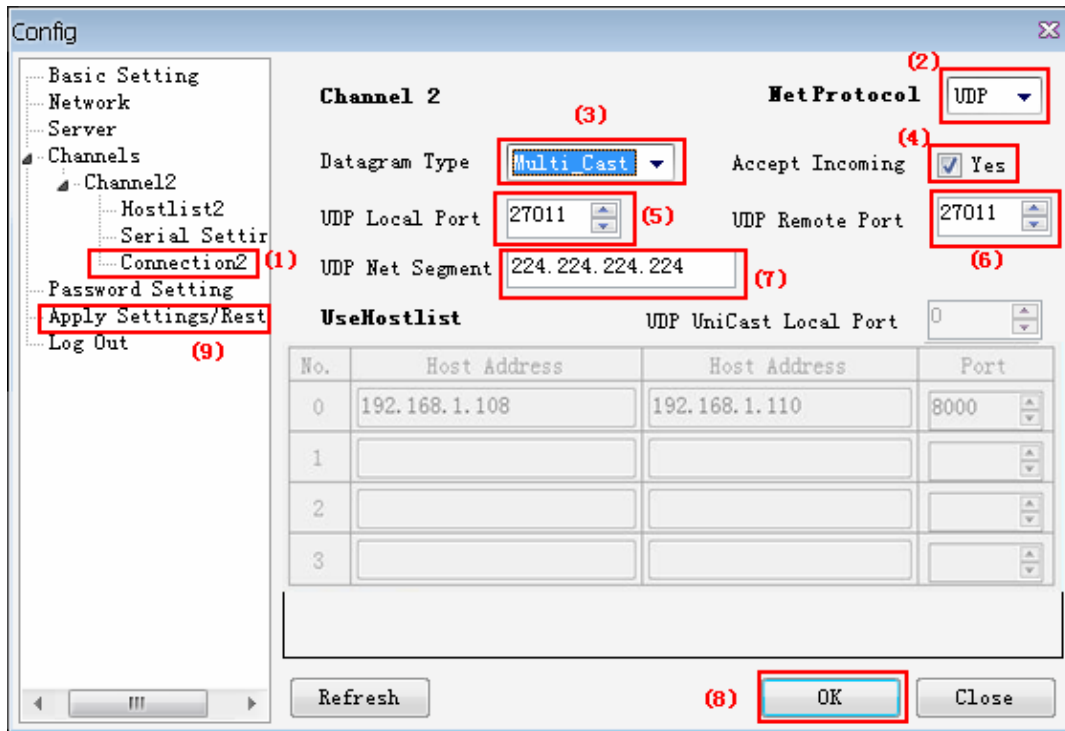

This mode is well suitable for upgrading the original RS485 network to Ethernet, the key of the mode is that all the ES-ETH-PPI multicast section address of the same group must keep identical to local port and remote host port number, that is to say, multicast section address and the port number is same, then these ES-ETH-PPI belong to the same group, the data sent out by any one will be received by other ES-ETH-PPI of the same group, and there is no master-slave distinction. Under the Multicast mode, the ES-ETH-PPI grouping is only logic, no need physical grouping, that is to say, there can be multiple groups in the same network, they are Independent of each other.

Of course, you still need to set each ES-ETH-PPI as a different IP address, every ES-ETH-PPI serial port parameters are the same as PLC serial port parameters.

(6) Remote communication in the internet

ES-ETH-PPI can achieve the worldwide remote communication through the Internet, it will use the external network IP address of the router, the router external network address is different when the router is started every time, because the router will be randomly assigned to one IP address from the Internet when it 's powered every time, so this will result in trouble for remote communication through the Internet, There are two following methods to solve this problem:

Apply to buy a fixed IP address from the telecom, the fee will be higher.

Use the dynamic domain name resolution. you can apply for a free or paid domain name from dynamic domain name service provider, then use domain name instead of IP address; so that regardless of changes in IP address, domain name will point to IP addresses in real time, like as we usually visit the website .

Some providers such as changeip.com and other dynamic domain name (DDNS) service providers offer free and paid dynamic domain name service, you can consult them for their dynamic domain name service and charges issue. Firstly you need to apply a dynamic domain from DDNS service provider , and download the Dynamic DNS client software, run this software on the host of Server mode. After the client software has been successfully started, Server host has solved the problem of dynamic IP address. Input the dynamic domain name in the IP input box of Client remote host, set the DNS server IP address as the local DNS server IP addresses, then you can use the dynamic domain name to visit the internet.

In the following example, use our free dynamic domain name:kollew.changeip.net, use the PC in Server-side and run the dynamic domain name client software, you can also use a router with the function of dynamic domain name .

1.STEP7 Micro/WIN software setting

Select RS485 communication mode switch on the ES-ETH-PPI to "10bit" , use the no parity 10 bit communication mode,then use the setting software to set ES-ETH-PPI serial port parameters as 9600bps,8N1 (8 data bits, no parity, 1 stop bit).

When the VCOMM virtual serial port software running on the PC simulate ES-ETH-PPI as the COM port on the PC, the next using is just like PC / PPI programming cable, but you should set the local connection in the "set PG/PC interface" menu of STEP7 Micro / WIN software as "modem connection" mode.

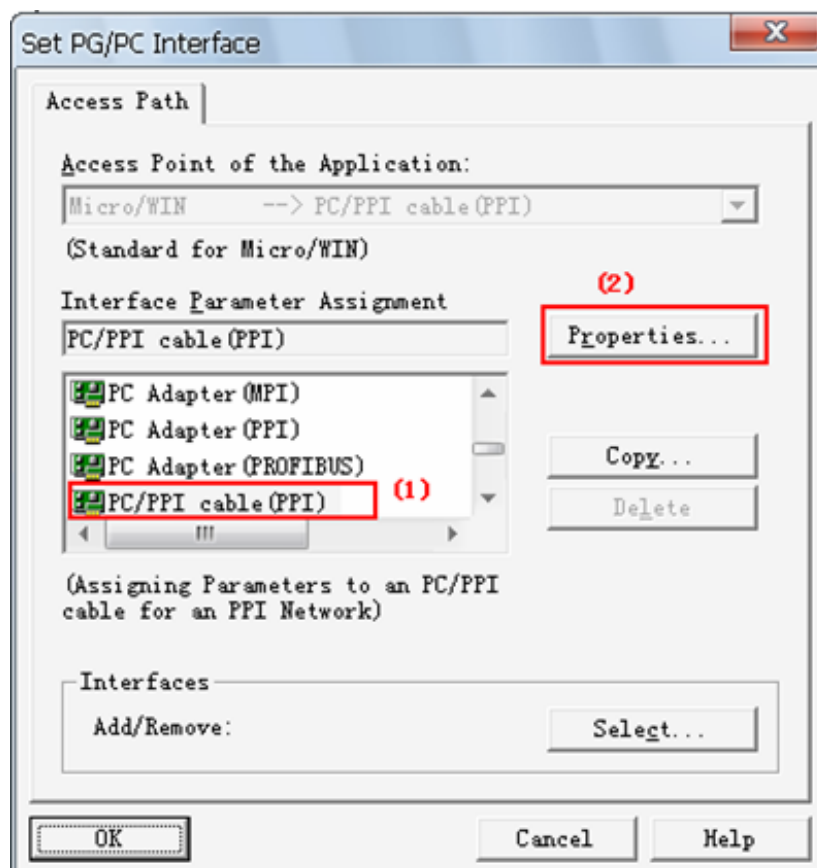

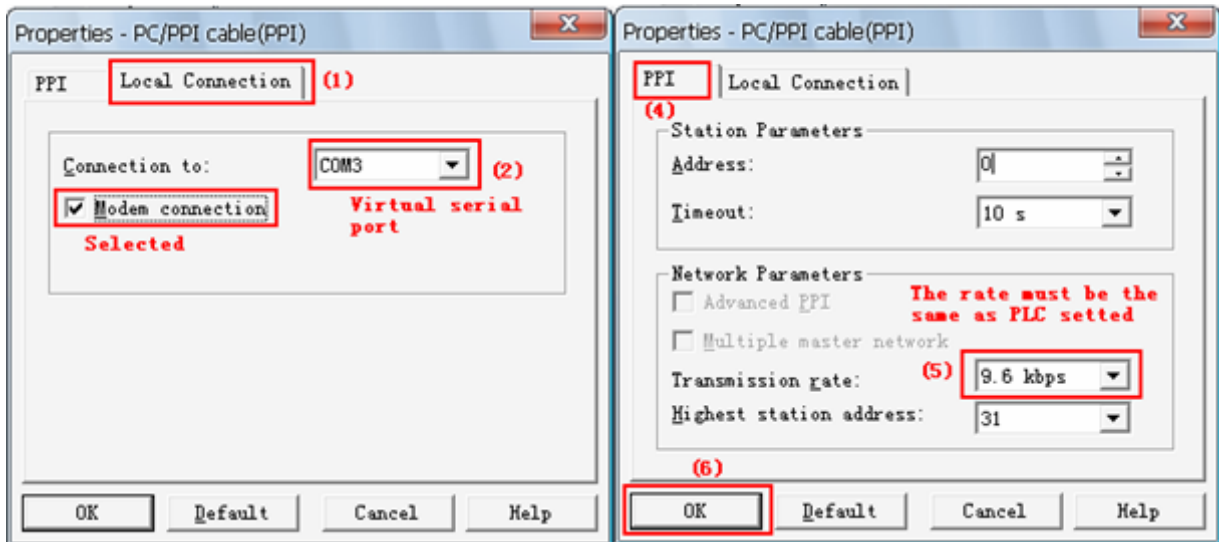

Click the "Communication" button to enter the communication settings, double-click "connection" to set the modem parameters.

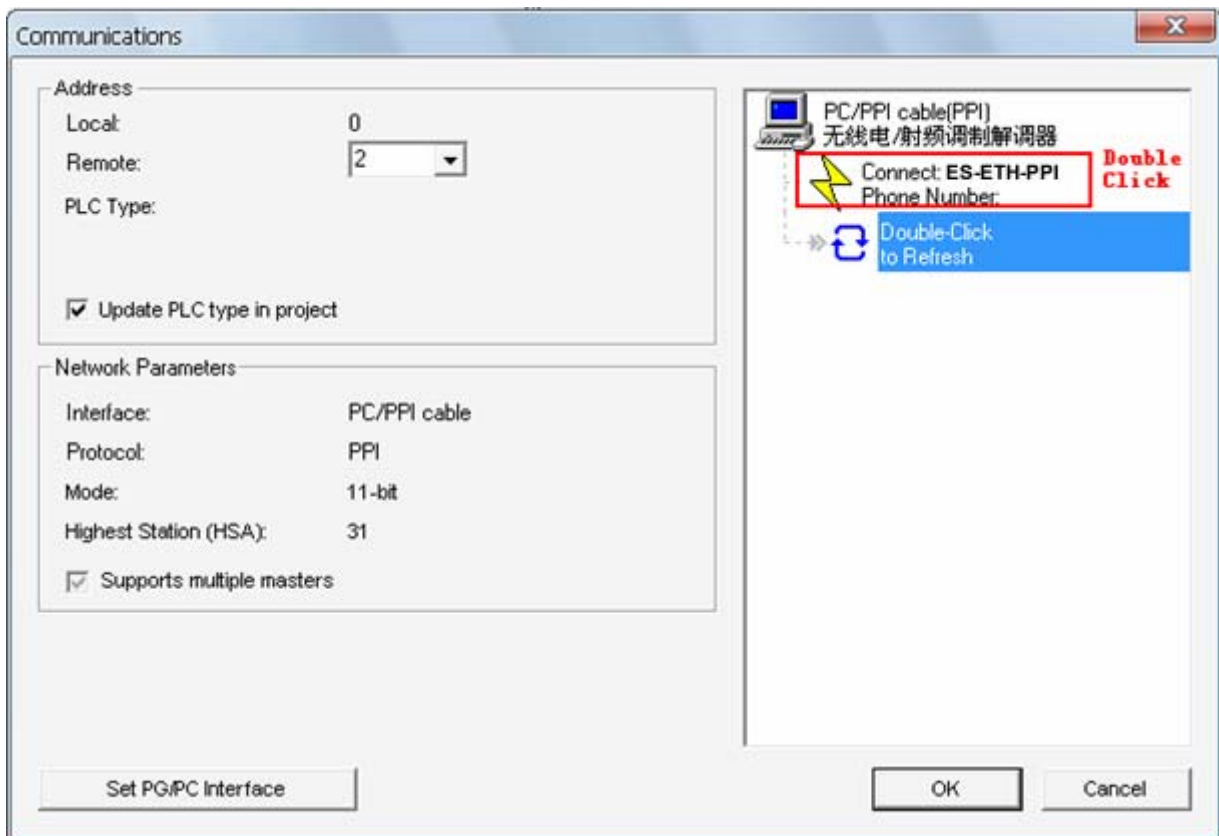

Select the "Radio / RF modem" and configure serial port parameters, choose no parity 10 bit mode.

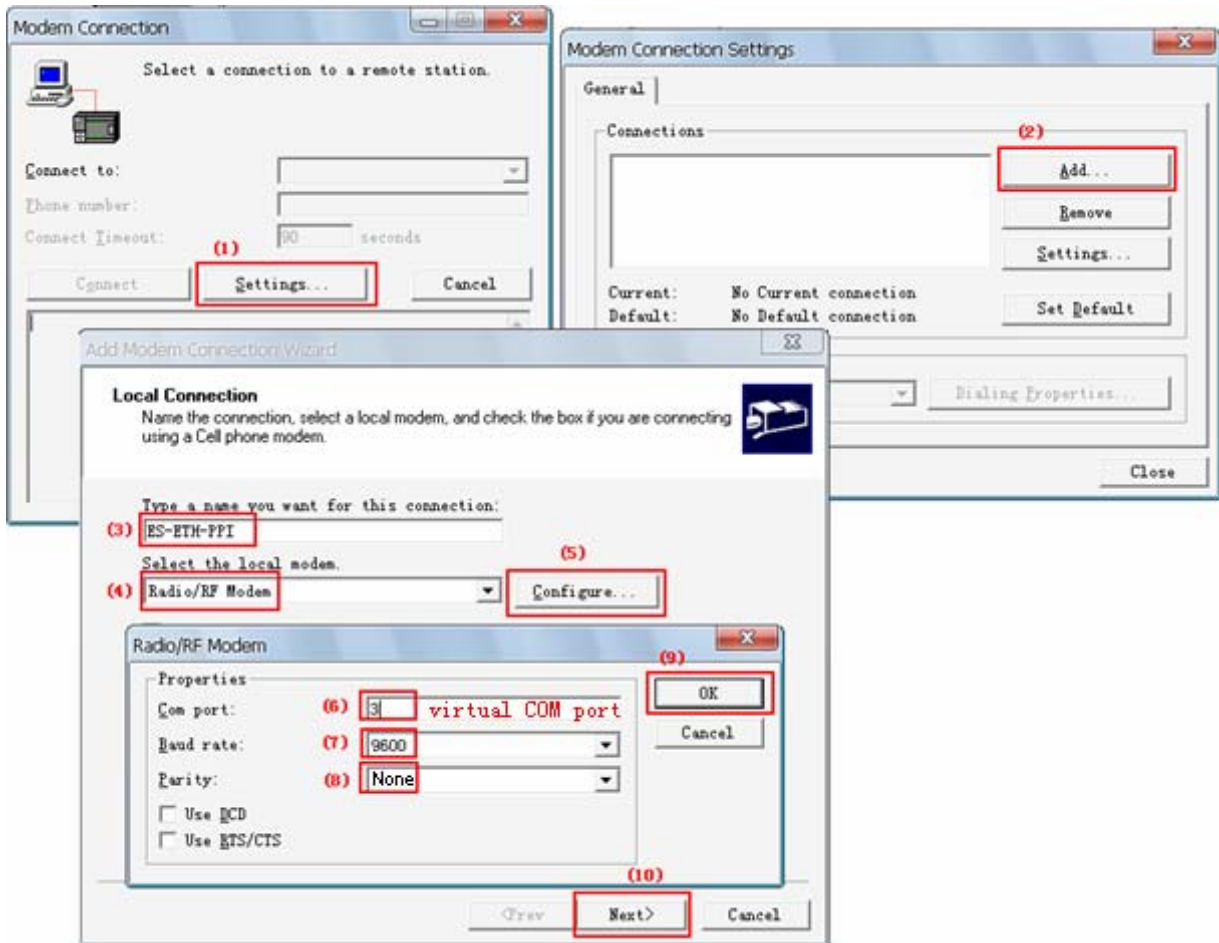

Click "Connect" button to establish the connection.

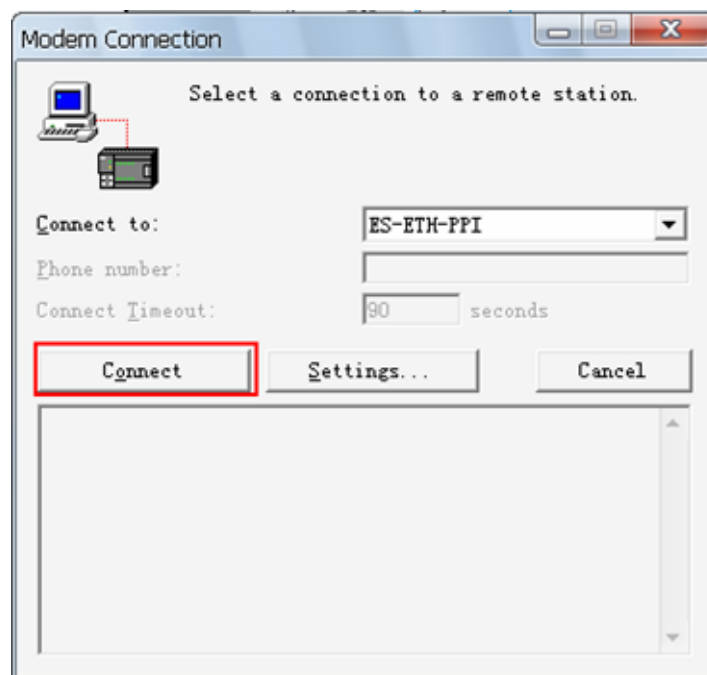

Double-click the "Refresh" to search the PLC, and then you can find the all PLCs connected to the network, then select the PLC which you want to operate, in the next step you can upload, download the data.

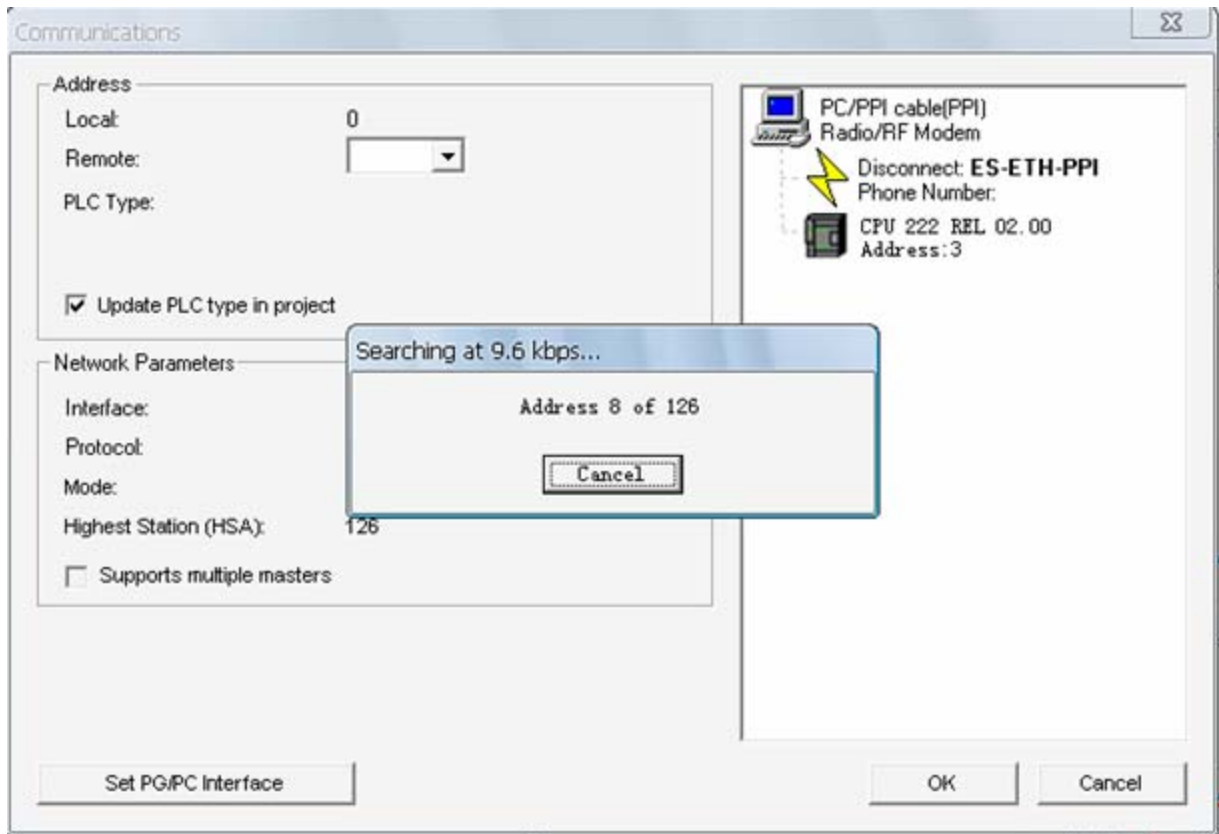

2.Remote communication between PC and S7-200PLC

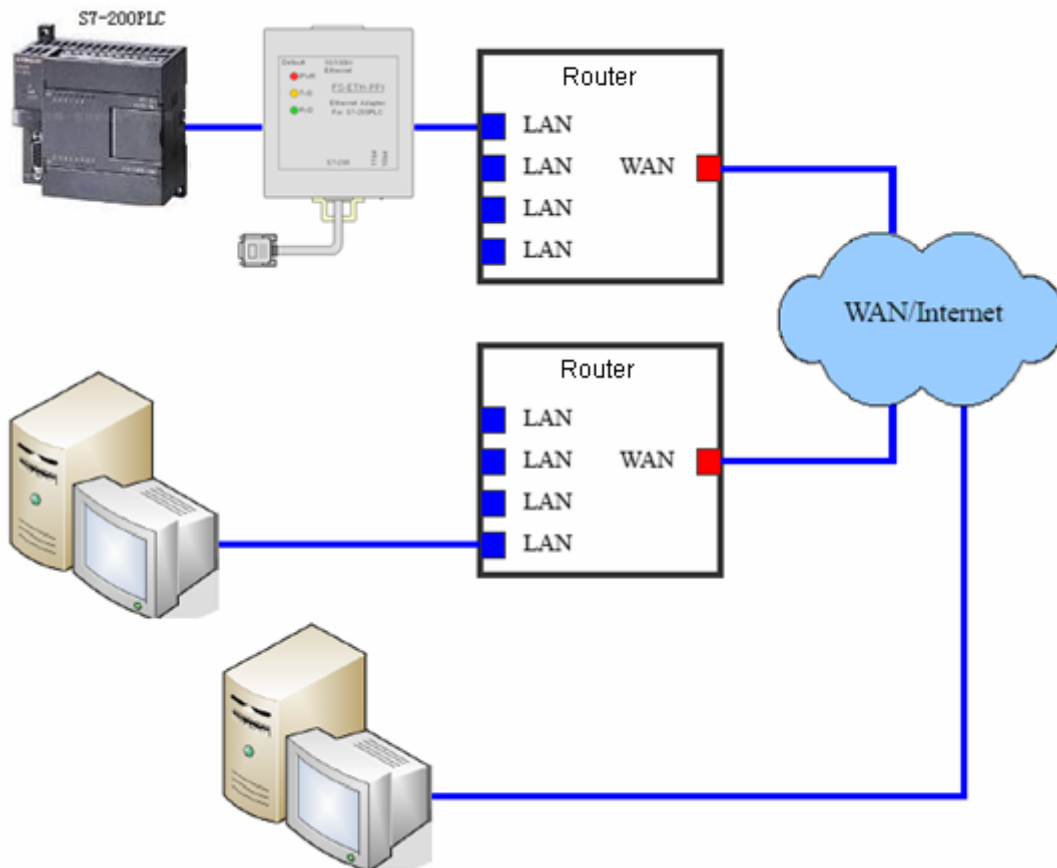

The most economical way to achieve the remote communication in the Internet between the PC and S7-200PLC is that set the ES-ETH-PPI as the client, set the PC as the server, install and run the DDNS software on the PC, and set the port mapping for PC on the router of PC side. As shown below:

Set ES-ETH-PPI network parameters, the gateway must be the same as the router connected with the ES-ETH-PPI, here you still need to properly set the IP address of DNS, different cities have different DNS Server IP, you can use all, but usually choose the local DNS, you can search these addresses from Internet, also can find them from the router which you are using.

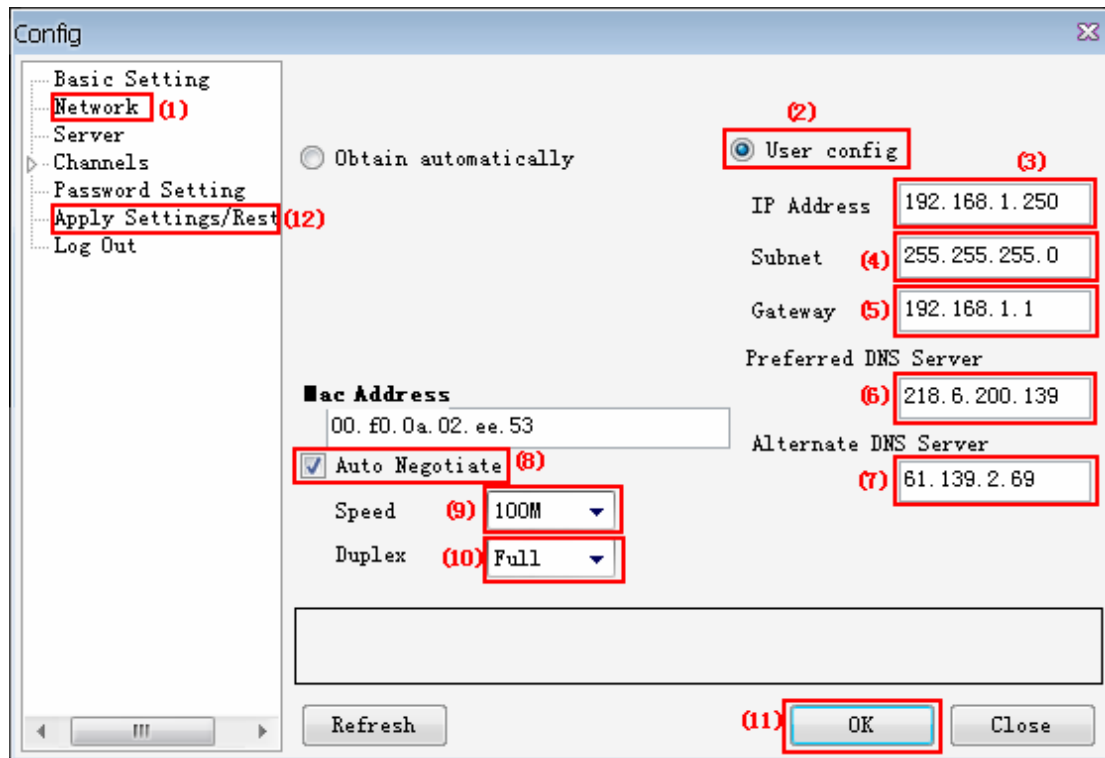

Set the serial port parameters of ES-ETH-PPI, please note that you should use 10-bit communication mode: 8 data bits, no parity, 1 stop bit, that is 8N1.

Set ES-ETH-PPI as TCP Client; remote host IP =domain name of remote PC, here is: kollew.changeip.net; host port = VCOMM software port number.

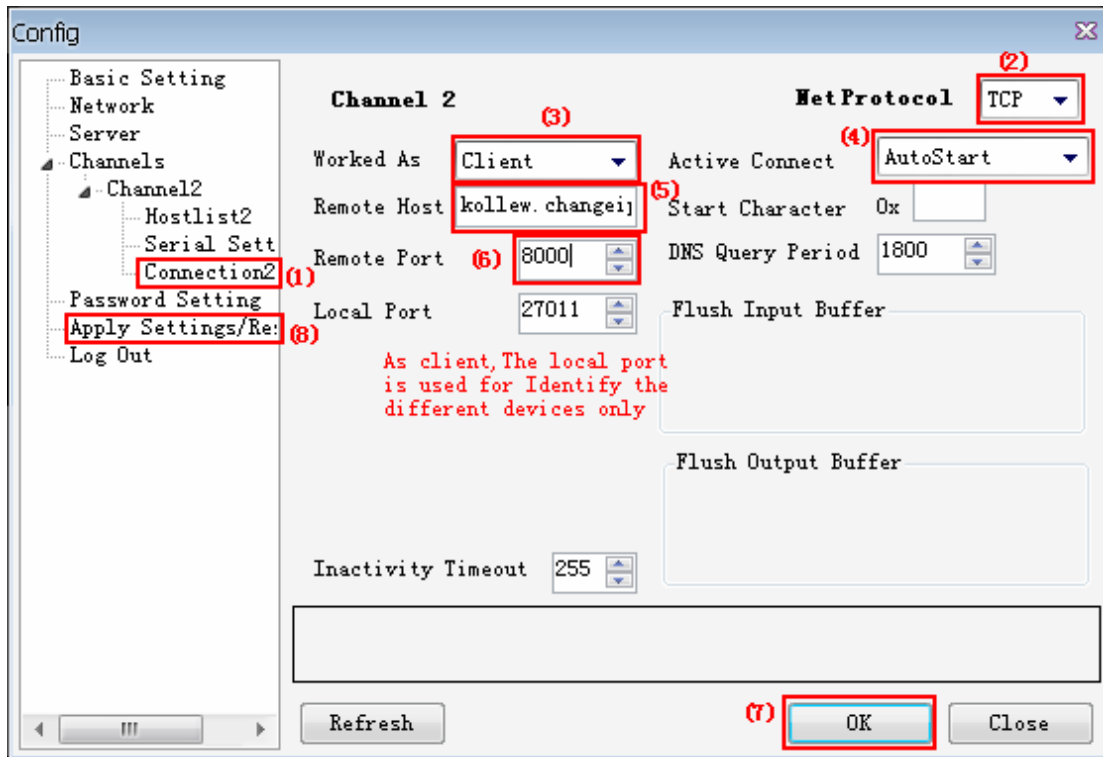

Input the IP address of the router in the IE browser address bar of the remote PC and then appear the router setting interface, set the port simulation for PC, as shown below. If your PC does not use the router to access Internet, then this step can be omitted.



Port Range					
Application	Start	End	Protocol	IP Address	Enable
Kollew	8000	to 8000	TCP	192.168.1. 108	<input checked="" type="checkbox"/>

The meaning of the above settings is that when the client ES-ETH-PPI visit and access the router's external network IP address (this address is automatically resolved by the domain name, you no longer cares about its change),router will automatically transfer this visiting to the VCOMM virtual serial port software on the PC with IP address 192.168.1.108, port 8000 which is connected to the router

After setting, click "Restart Router" button or re-power the router to work with the new parameters. Run the client software on the PC, as shown below, the domain name kollew.changeip.net has been pointed to the external network IP address of the router.

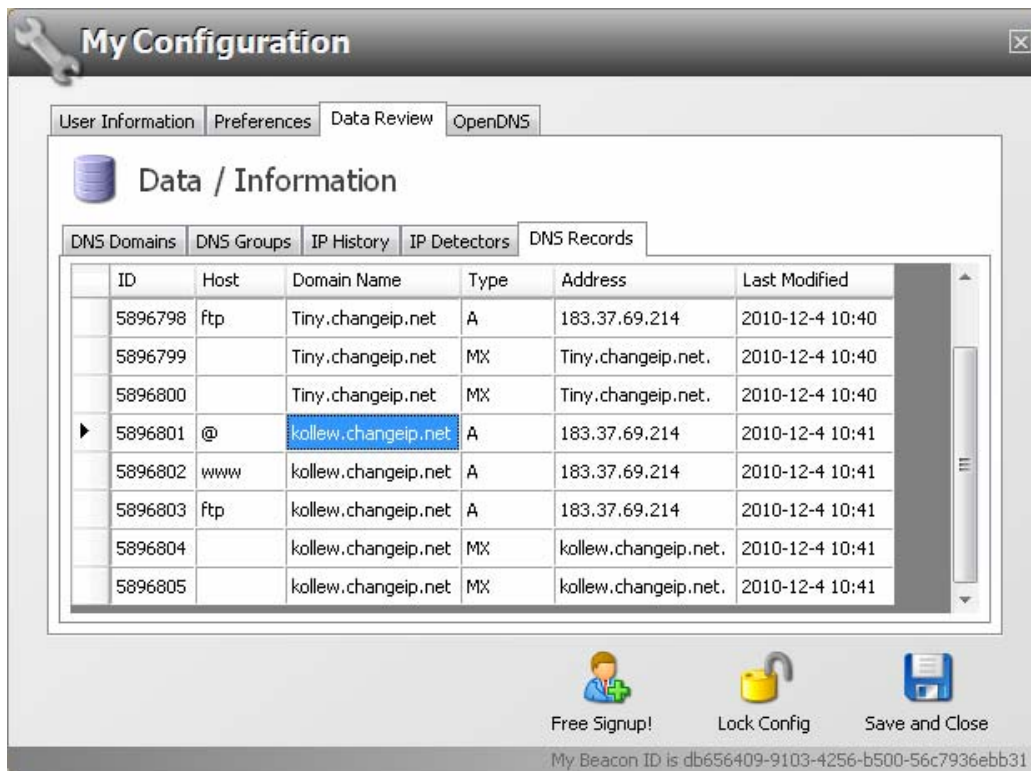

Run the VCOMM virtual serial port software on the PC, set the simulated virtual serial port on the PC. Select VCOMM as Server mode, accept client connections. Choose to use the device detector to create a virtual serial port.

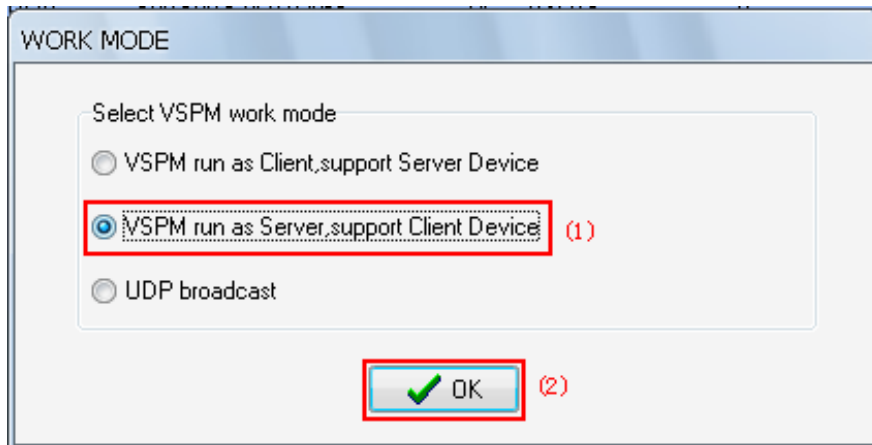

Add a new virtual serial port, the monitoring IP address = PC IP address, client mode device try to connect the port = VCOMM software port, this is 8000.

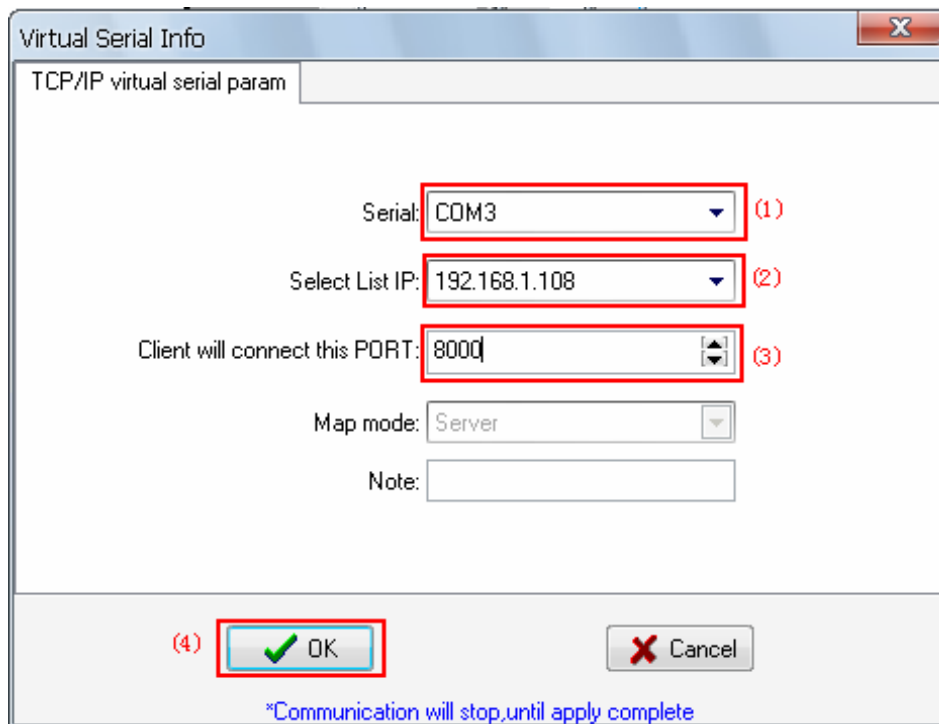

Click OK and exit the software and re-run VCOMM, the server VCOMM will wait the connection of client ES-ETH-PPI, then it will create a new serial port COM3 after establishing the connection, and it will appear in the Device Manager of the Windows system, then you choose this serial port in your application software, such as STEP7 Micro/WIN.

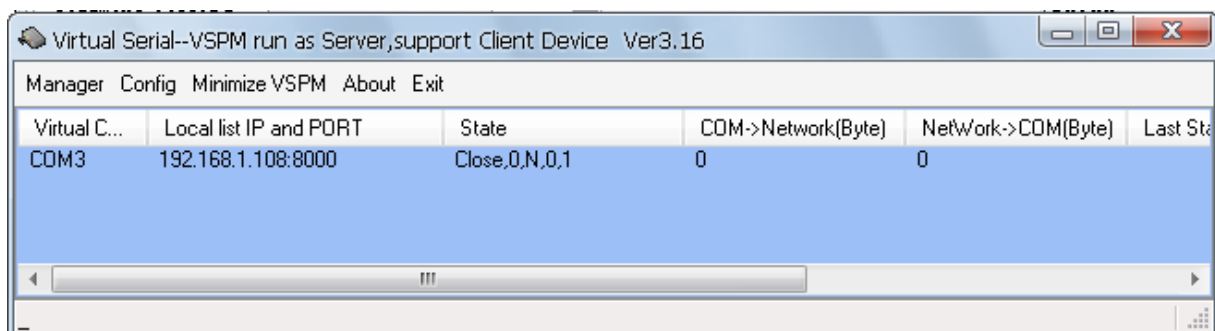

You can also set the ES-ETH-PPI as the server, set VCOMM as the client, but the router connected with ES-ETH-PPI need to have the DNS function, or you can use a PC connected to the router which is connected with the ES-ETH-PPI to run the peanut shell software to resolve the domain name. When the VCOMM software work as the client, you also could input the domain name directly in the remote server IP address, support DNS resolution.

Of course you can use multiple ES-ETH-PPI to simulate multiple PLC as multiple COM port on the PC (set the connection with multiple different ports), in order to achieve the data communication and control operation of the PC and multiple PLC respectively.

3.Remote communication between two PCS S7-200PLCs

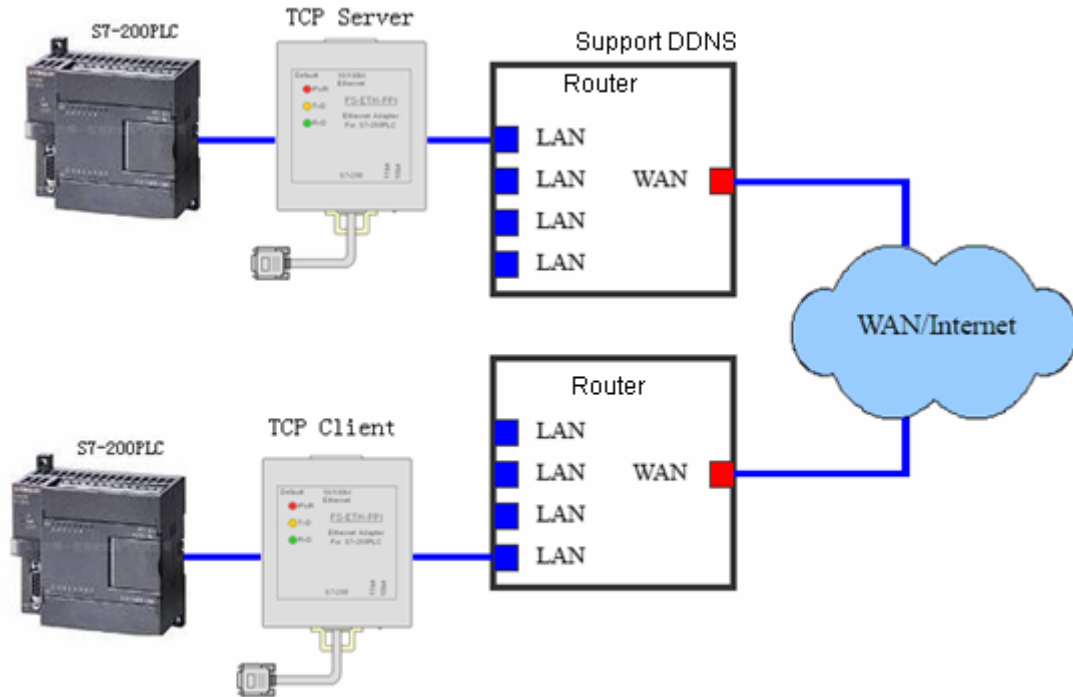

Two pcs S7-200PLC can achieve remote communication on the Internet via the ES-ETH-PPI, you need a router which supports dynamic domain name (DNS),in order to avoid the high cost of fixed IP address from the local telecom, and this router is very common now, please notice the instructions on the package when you purchase it.

Please notice that when the two PLCs are communicated via ES-ETH-PPI, you only can use the RS485 free port communication protocol,not support PPI, advanced PPI, multi-master PPI protocol, MPI and PROFIBUS protocol.

Use two pcs ES-ETH-PPI to connect with two pcs S7-200PLC,the switch of communication mode select 11 or 10 bit, it depends on the free port RS485 protocol communication parameters which are setted in your PLC.

11-bit mode: 8 data bits, even parity, 1 stop bit (8E1)

10-bit mode: 8 data bits, no parity, 1 stop bit (8N1)

set one of ES-ETH-PPI as client,set the other ES-ETH-PPI as server,the router of server side needs to have the DNS function,and can normally run the domain name on this router,as shown below.

Enter the dynamic DNS setting interface of router, input the user name and password of the Dynamic DNS which you applied,as shown below,then you can find our domain name kollew.changeip.net is connected successfully.



Click "Restart Router" button or re-power the router to work with the new parameters.

Similarly, when two pcs ES-ETH-PPI go on external network communication,you need to set the port simulation on the router connected with the server ES-ETH-PPI,input the IP address of router in the IE browser of PC connected with this router and then enter the virtual server setting interface of the router.



The server port = local port of server ES-ETH-PPI; IP address = IP address of server ES-ETH-PPI; Select the "Enable", click "Save" button to save these configured parameters.

Set the parameters of server ES-ETH-PPI as below:

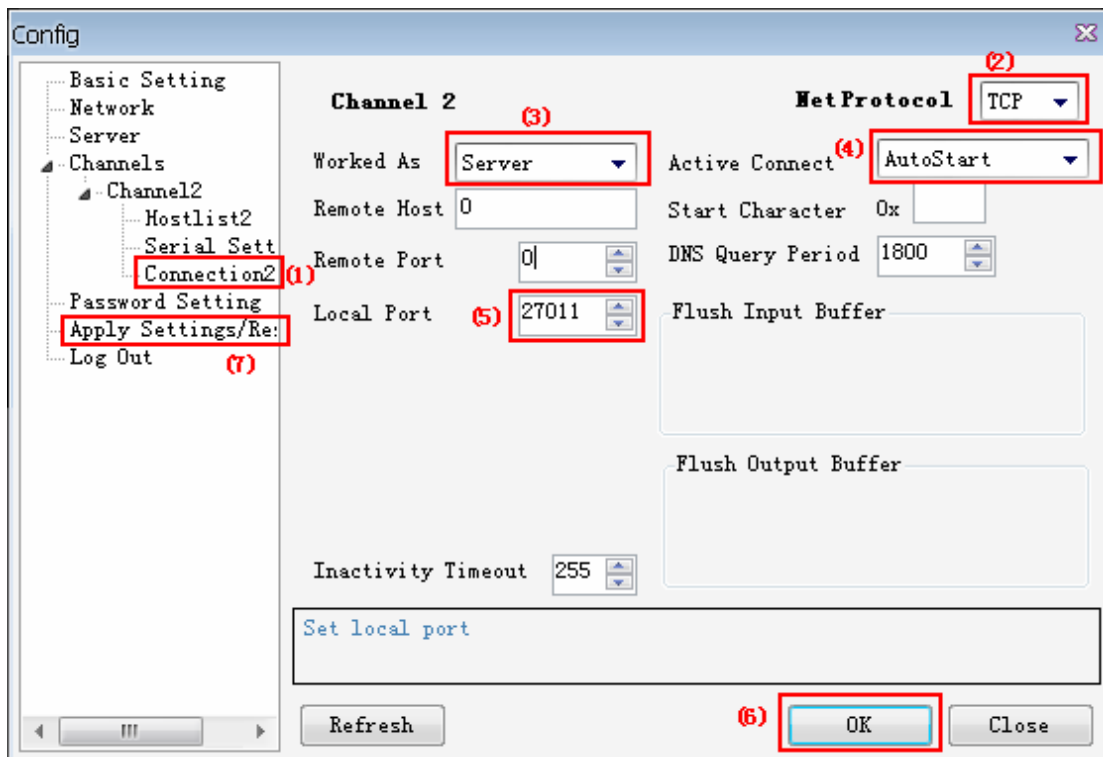
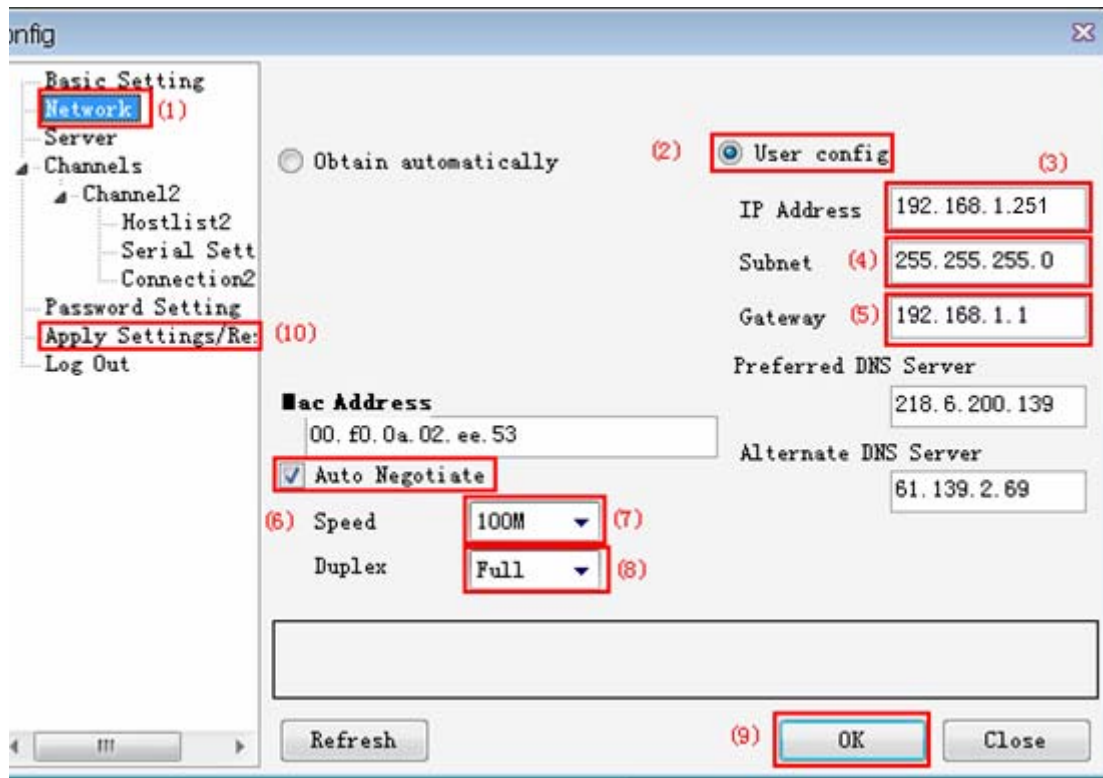

Set the parameters of client ES-ETH-PPI as below:

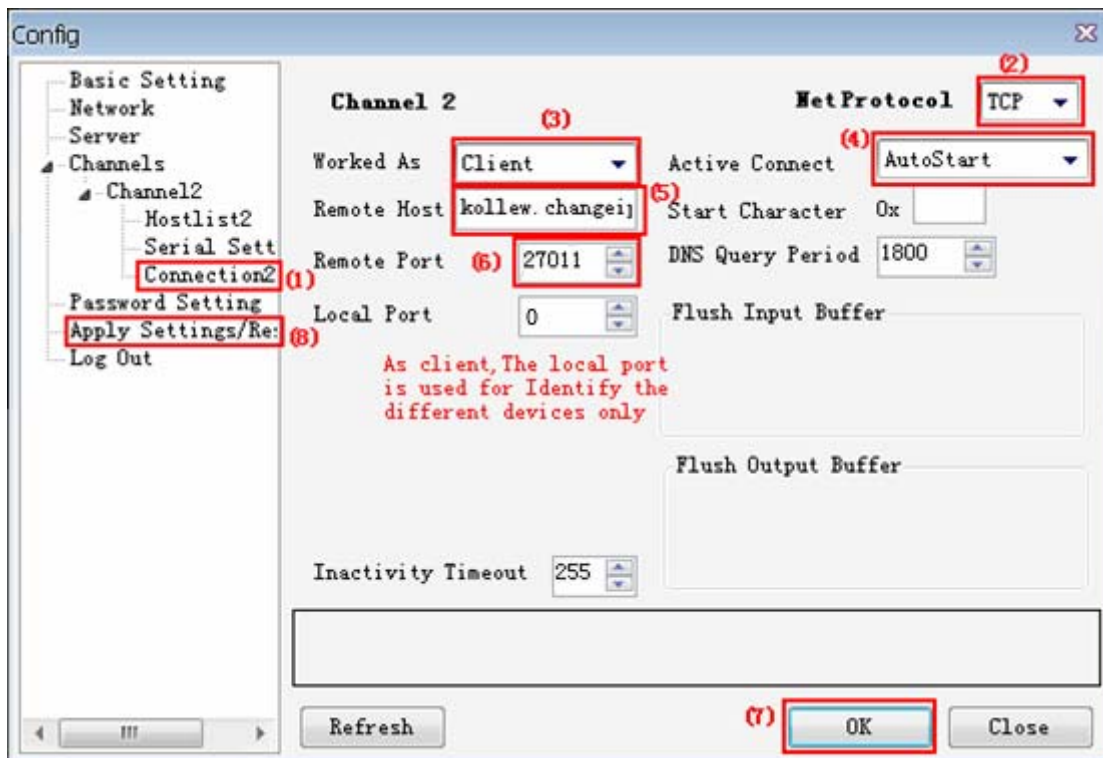
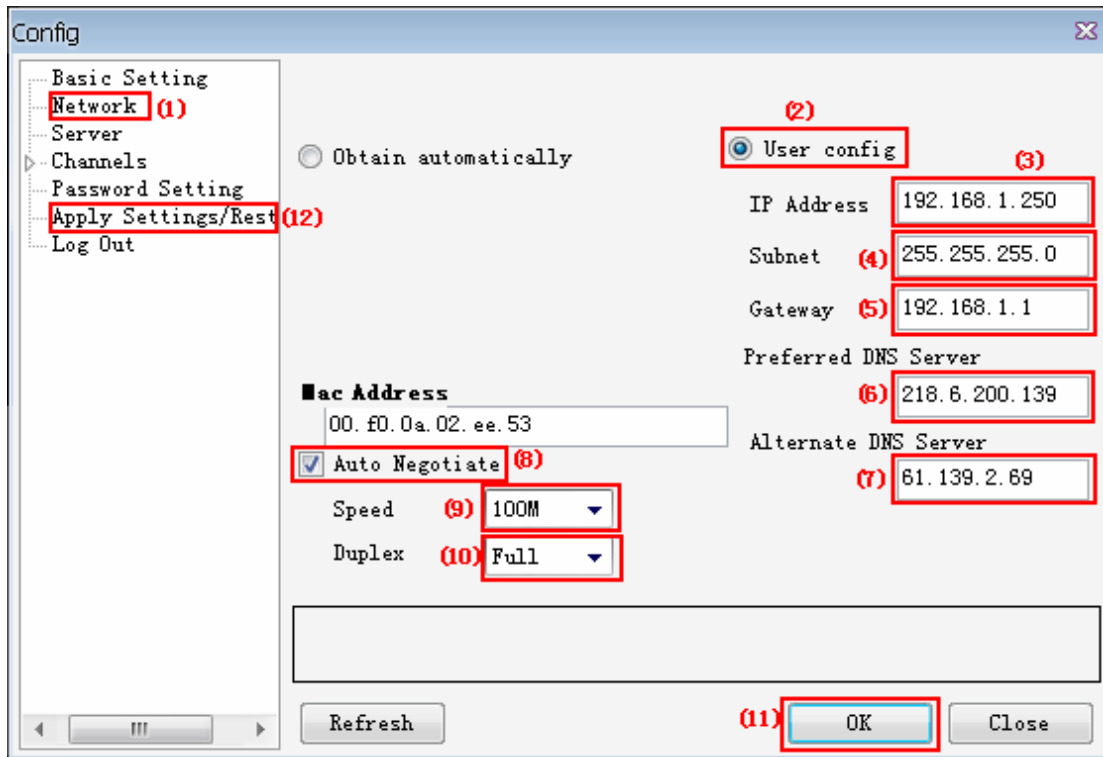

Please note that you need to properly set the DNS server of the client ES-ETH-PPI, input the domain name kollew.changeip.net in the remote host IP box, host port is the port number of server ES-ETH-PPI. So that when the client ES-ETH-PPI connect the domain name of Internet, it will automatically connect to the Internet address (the external network IP address) of the server-side router, the router automatically transfer to the server module, achieve the remote communication from S7-200PLC's serial port to another S7-200PLC's serial port.

(7) Remote wireless communication in the 3G wireless internet

Using the wireless Internet platform of telecom, all the Ethernet to Serial port modules can be very convenient to achieve wireless communication, that is to say, you can use the wireless router to achieve the wireless communication in the LAN, you can also use the 3G router , 3G network card to achieve the worldwide Internet wireless communication. As long as any places where the wireless Internet is available, then the wireless communication between the S7-200PLC and PC, S7-200PLC and PLC can be achieved, which has extended a broader application range.

In fact when you use wireless communication, the setting method is almost as same as the previous introduction., only 3G router, wireless network card of different manufacturers may have some differences in the usage, so please read the corresponding product manual. When the ES-ETH-PPI works as the server, it is best to use the 3G router with the function of dynamic domain name to connect the ES-ETH-PPI.

User should pay an attention on that the current TD-SCDMA 3G Mobile and China Unicom's WCDMA 3G network card are using a private network IP address, this can only be used as a client, can not be accepted as a client server. and Telecom's CDMA2000 EVDO 3G network card is using a public network IP address, and this can be used as server or client to use.

The following are programs of wireless communication in the Internet wireless network platform. The both parties of communication can be both 3G wireless network, but also one is 3G wireless network, the other is the wired Internet.

1.STEP7 Micro/WIN software setting

When 3G etc other wireless network work as the external network communication, STEP7 Micro / WIN software settings are the same as the introduction of previous(6) -1 article. So please choose the no parity 10 bit communication mode of "Radio / RF modem "connection.

Of course, the mode switch on the ES-ETH-PPI need to select "10bit".

2. Remote wireless communication between PC and S7-200PLC

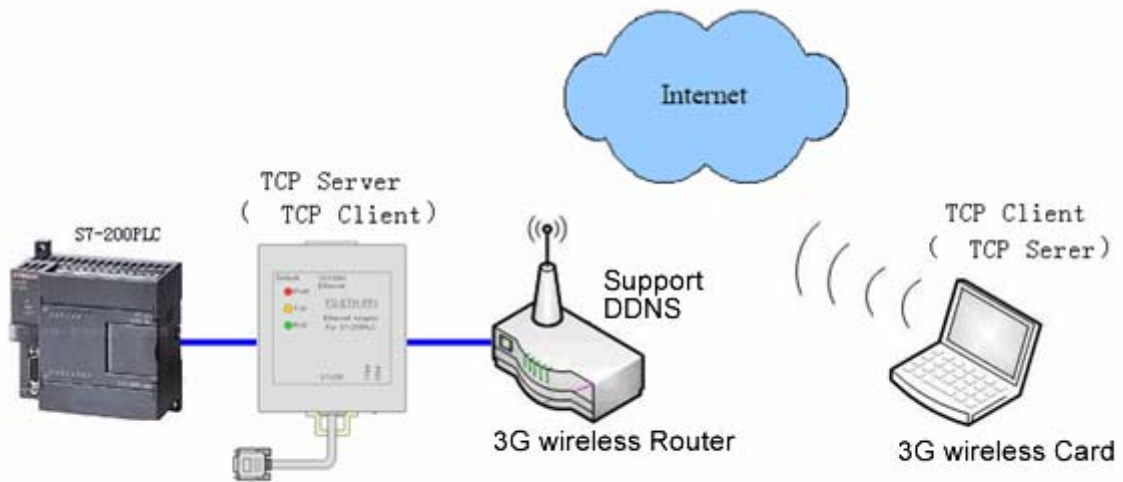

3. Remote wireless communication between two PCS S7-200PLCs

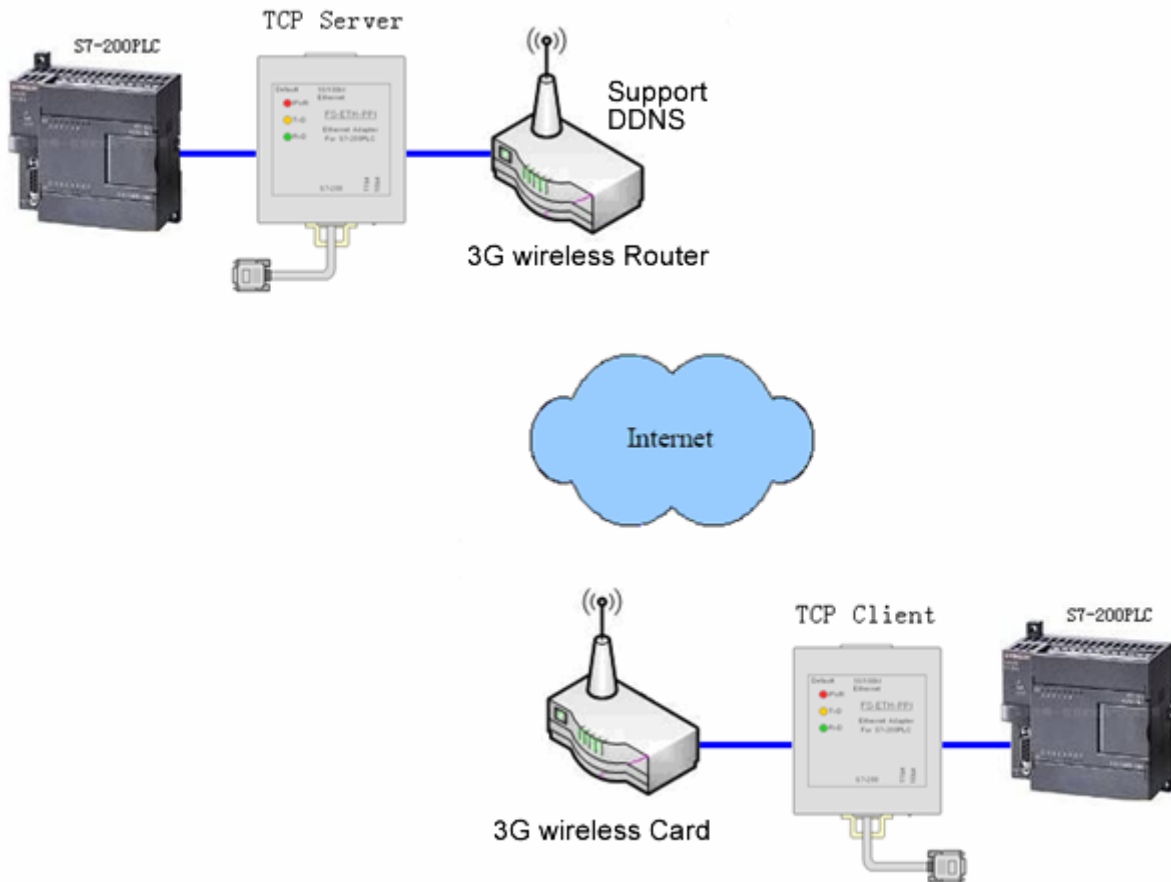

(8)Ordering Info

Product Name: Siemens S7-200PLC Ethernet Adapter

Model: ES-ETH-PPI

Appendix: basic knowledge of Ethernet

(9)Appendix: basic knowledge of Ethernet

TCP / IP transport layer provides two common agreements of TCP and UDP, the two protocols provide the transmission mechanism of TCP / IP network applications. TCP provides a guaranteed and reliable information transmission, and UDP use non-guaranteed and non-reliable method to transmit information.

1.TCP mode

TCP is a guaranteed connection based protocol, before transmitting, the equipment must first establish duplex connection, disconnect after data transfer is complete. Sending the data need to receive confirmation of the host then continue sending data, if not received confirmation of the host or data error, need a certain number of retransmissions. In this way it will be additional traffic, so slowly than UDP.

TCP communications, including the client (Client) and server (Server), the client take the initiative to connect to the server, the server can only be a passive client connections, once establish the connection, the client and server can be duplex data transfer at any time.

Our Ethernet to serial communication module using TCP mode including: TCP Server, TCP Client.

TCP Server (TCP Server) mode:

When the module works in the TCP Server mode, it does not take the initiative to connect to other devices, but listening on local port, and wait for client connections, if the client can establish a connection then will go on the duplex communications.

TCP Client (TCP Client) mode:

When the module works in the TCP Client mode, it will take the initiative to connect the setted TCP server in advance, if the connection is not successful, it will continue to attempt to reconnect, once

the connection success the server will go on the duplex data communications.

2.UDP mode

UDP protocol is unreliable connectionless protocol, data transmission is not required to establish a connection, do not need to receive confirmation form the host for data transmission, so the UDP protocol does not guarantee the data sent to the target host packets are received correctly, for high reliability requirements of the occasion can use the higher level of communication protocol to ensure data is correct.

UDP is a relatively simple way of communication, it will not increase too much extra traffic, it can communicate faster than the TCP to provide real time communication. UDP does not need the server and client, both parties are on equal communication.

Our Ethernet to serial communication module using UDP mode including: UDP Uni_Cast, UDP Multi_Cast.

UDP unicast (UDP Uni_Cast) mode:

Module in the UDP Uni_Cast mode, it can be point to point duplex data transmission, although it can send data to several other hosts, but only one host can send data to the module back .

UDP Multicast (UDP Multicast) mode:

The modules in the network use the multicast ID is one between 224.0.0.0-239.255.255.255 address as its multicast group address, all the modules in the multicast network can be duplex data transfer, and no master slave distinguish, This mode is easy for old RS485 network upgrade to Ethernet.